

RD7000™+

**Radiodetection's utility specific
cable and pipe locators**



Operation Manual | Issue 1 | January 2011

90/RD7K+-OPMAN-ENG/01



Radiodetection®
AN SPX COMPANY

EDENBROS, LLC

PO BOX 247

ST. JAMES, MO 65559

Phone: +1 800-526-5246

Fax: +1 800-807-9368

sales@edenbros.com

www.edenbros.com

Preface

Before you begin

Thank you for your interest in Radiodetection's RD7000+ cable and pipe locator.

The RD7000+ delivers the very latest in cable and pipe location technology in a powerful yet ergonomic and light-weight design.

Please read this user manual before attempting to use the RD7000+ system.

Radiodetection products, including this manual, are under continuous development. The information contained within is accurate at time of publication; however the RD7000+, this manual and all its contents are subject to change.

Radiodetection Limited reserves the right to modify the product without notice and some product changes may have taken place after this user manual was published.

Contact your local Radiodetection dealer or visit www.radiodetection.com for the latest information about the RD7000+ product family, including this manual.

Important notices

General

The performance of any cable and pipe locator may be affected when used in close proximity to ferrous materials such as manhole covers, steel-toe boots and nearby vehicles. Keep a distance of one or two meters from these objects when taking critical measurements such as depth and current readings.

This instrument, or family of instruments, will not be permanently damaged by reasonable electrostatic discharge and has been tested in accordance with IEC 61000-4-2:1995. However, in extreme cases temporary malfunction may occur. If this happens, switch off, wait and switch on again. If the instrument still malfunctions, disconnect the batteries for a few seconds.

Safety

This equipment shall be used by fully qualified and trained personnel only.

Radiodetection locators detect almost all buried cables and most conductors, but there are some which do not radiate signals and which Radiodetection locators cannot detect. Radiodetection locators do not indicate whether a signal is from a single cable, several buried side by side or one above another. Exercise caution and due diligence when conducting any survey.

⚠ Making a direct connection to live power lines is extremely dangerous to life. Do not attempt any direct connection unless you are fully trained and qualified to do so.

⚠ WARNING! The transmitter is capable of outputting potentially lethal voltages. Take care when applying signals to any pipe or cable and be sure to notify other technicians who may be working on the line.

⚠ WARNING! Reduce audio level before using headphones to avoid damaging your hearing.

⚠ WARNING! This equipment is NOT approved for use in areas where hazardous gases may be present.

⚠ WARNING! When using the transmitter, switch off the unit and disconnect cables before removing the battery pack.

⚠ WARNING! The RD7000+ will detect almost all buried conductors but there are some objects that do not radiate any detectable signal. The RD7000+, or any other electromagnetic locator, cannot detect these objects so proceed with caution. There are also some live cables which the RD7000+ will not be able to detect in Power mode. The RD7000+ does not indicate whether a signal is from a single cable or from several in close proximity.

Batteries

⚠ WARNING! Batteries can get hot after prolonged use at full output power. Take care while replacing or handling the batteries.

Battery disposal

Batteries should be disposed of in accordance with your company's work practice, and/or the relevant laws or guidelines in your country or municipality.

FCC and Industry Canada statements

This device complies with part 15 of the FCC Rules. Operation is subject to the following conditions: (1) This device may not cause harmful interference, and (2) this device must accept any interference received, including interference that may cause undesired operation.

Changes or modifications not expressly approved by the party responsible for compliance could void the user's authority to operate the equipment. To comply with the FCC requirements, this device and its antenna must not be co-located or operated in conjunction with any other antenna or transmitter.

Equipment is for use by trained operators only and not for general household use. Usage duration shall be as short as possible to prevent possible radio interference to authorized services, especially the 100 kHz Loran-C frequency.

This Category II radiocommunication device complies with Industry Canada Standard RSS-310.

Ce dispositif de radiocommunication de catégorie II respecte la norme CNR-310 d'Industrie Canada.

Training

Radiodetection provides training services for most Radiodetection products. Our qualified instructors will train equipment operators or other personnel at your preferred location or at Radiodetection headquarters.

For more information go to www.radiodetection.com or contact your local Radiodetection representative.

Trademarks

RD7000, RD7000+, RD8000, RD4000, eCAL, Centros, TruDepth, SideStep, SideStep*auto* and StrikeAlert are trademarks of Radiodetection Ltd.

Windows, Windows Vista and XP are registered trademarks of Microsoft Corporation, all rights reserved.

The Bluetooth word mark and logos are owned by the Bluetooth SIG, Inc. and any use of such marks by Radiodetection is under licence.

Copyright statement

This manual is Copyright © 2010 Radiodetection LTD – SPX Corporation. All rights reserved. Radiodetection LTD is a subsidiary of SPX Corporation.

This manual may not be copied, reproduced or sold in whole or in part without expressed written permission by Radiodetection Ltd. Please direct all copyright and publishing queries to your local Radiodetection representative.

Table of contents

Preface	i		
Before you begin	i		
Important notices	i		
General	i		
Safety	i		
Batteries	i		
FCC and Industry Canada statements	ii		
Training	ii		
Trademarks	ii		
Copyright statement	ii		
Section 1 – Introduction	1		
1.1 About this manual	1		
1.1.1 Additional documentation	1		
1.2 About the RD7000+	1		
1.3 Manual outline	1		
1.4 Safety	1		
Section 2 – System overview	3		
2.1 RD7000+ locator	3		
2.1.1 Locator features	3		
2.1.2 Locator keypad	3		
2.1.3 Locator screen icons	3		
2.2 Tx-1, Tx-3 and Tx-10 transmitters	5		
2.2.1 Transmitter features	5		
2.2.2 Transmitter keypad	5		
2.2.3 Transmitter screen icons	5		
Section 3 – Basic operation	6		
3.1 Starting the system	6		
3.1.1 D-cell (LR20) Batteries	6		
3.1.2 Rechargeable battery packs	6		
3.2 System setup	6		
3.2.1 Power frequency (locator only)	6		
3.2.2 Language	7		
3.2.3 Units (locator only)	7		
3.2.4 Battery type	7		
3.3 Using the menu	7		
3.3.1 Navigating the locator menu	7		
3.3.2 Locator menu options	7		
3.3.3 Navigating the transmitter menu	8		
3.4 Shutting down	8		
3.5 Headphones	8		
3.6 Frequencies	8		
3.6.1 Passive frequencies	8		
3.6.2 Active frequencies	8		
3.6.3 Selecting frequencies	9		
3.7 TruDepth™ measurement	9		
3.8 SideStepauto™	9		
3.8.1 Using SideStepauto	9		
3.9 Dynamic Overload Protection	9		
3.10 StrikeAlert™	10		
3.10.1 Using StrikeAlert	10		
3.11 Antenna modes	10		
3.12 Backlight	10		
3.13 Audio	10		
3.14 Transmitter power output	11		
3.14.1 Adjusting power output	11		
3.14.2 Boost (Tx-3 and Tx-10 only)	11		
Section 4 – Locating cables and pipes	12		
4.1 Antenna modes	12		
4.1.1 Peak mode	12		
4.1.2 Null mode	12		
4.1.3 Combined Peak/Null mode	12		
4.2 Compass	12		
4.3 Trace	13		
4.4 Pinpoint	13		
4.5 Sweep and search	14		
4.5.1 Passive Sweep	14		
4.5.2 Inductive search	14		
Section 5 – Depth and current readings	16		
5.1 Depth readings	16		
5.1.1 TruDepth and Compass	16		
5.2 Verifying depth measurements	17		
5.2.1 Rough depth calibration check	17		
5.3 Current readings	18		
5.3.1 Identification using current measurements	18		
5.3.2 About current measurements	18		
5.3.3 Applying a transmitter signal	19		
5.3.4 Signal current measurements	19		
Section 6 – General Locating tips	20		
6.1 Eliminating services	20		
6.1.1 Induction	20		
6.1.2 Unwanted signal coupling	20		
6.2 Signal grounding	21		

6.2.1	Manhole covers	21	9.4	Upgrading software	33
6.2.2	Using lighting columns	21	9.5	Care and maintenance	34
6.2.3	Finding a good ground point	21	9.5.1	General	34
6.3	Double-ended connections	22	9.5.2	Batteries and power supply	34
6.3.1	Making a double-ended connection	22	9.5.3	Cleaning	34
			9.5.4	Disassembly	34
			9.5.5	Service and maintenance	34
Section 7	– Using Accessories	23	Section 10	– Appendices	35
7.1	About accessories	23	10.1	Specifications for the locator and transmitter	35
7.2	Locator clamps	23	10.2	Supported frequencies	35
7.2.1	When to use clamps	23	10.3	Supported accessories	36
7.2.2	Connecting a clamp	23			
7.2.3	Available locator clamps	24	Table of figures		
7.3	Transmitter clamps	24	Figure 2.1:	RD7000+ locator	2
7.3.1	Connecting the clamp	24	Figure 2.2:	locator keypad	2
7.3.2	Available transmitter clamps	25	Figure 2.3:	locator LCD	2
7.4	Sondes	25	Figure 2.4	RD7000+ transmitter	4
7.4.1	When to use a sonde	25	Figure 2.5:	Rechargeable battery pack	4
7.4.2	Choosing a suitable sonde	25	Figure 2.6:	transmitter keypad	4
7.4.3	Preparation	25	Figure 2.7	transmitter LCD	4
7.4.4	Propelling a sonde	25	Figure 4.1	Line tracing	13
7.4.5	Locating and tracing a sonde	26	Figure 4.2:	Pinpointing a target line	13
7.4.6	Checking sonde depth	27	Figure 4.3:	Pinpointing with Peak/Null	13
7.4.7	Types and range of sondes	27	Figure 4.4:	Passive sweep	14
7.5	Stethoscopes	28	Figure 4.5:	Inductive search	15
7.5.1	When to use a stethoscope	28	Figure 5.1:	Taking a depth reading	16
7.5.2	How to use a stethoscope	28	Figure 5.2:	Depth readings	16
7.5.3	Types of stethoscope	28	Figure 5.3:	Current readings	18
7.6	Submersible antenna	28	Figures 5.4 – 5.6:	Taking current readings	18
7.6.1	When to use a submersible antenna	28	Figure 5.7:	Current readings using transmitter signals	19
7.6.2	How to use a submersible antenna	28	Figures 6.1 – 6.4:	Interference from services	20
Section 8	– Fault-Finding	30	Figure 6.5:	Making double-ended connections	22
8.1	About fault-finding	30	Figure 7.1:	Connecting a locator clamp	23
8.2	Preparation	30	Figure 7.2:	Standard clamp	24
8.2.1	Connecting the transmitter	30	Figures 7.3 – 7.4:	Connecting transmitter clamps	24
8.2.2	Reference readings	30	Figure 7.6:	Sonde deployment	26
8.3	How to find a fault	31	Figure 7.7:	Locating a sonde	26
			Figure 7.8:	Calculating sonde depth	26
Section 9	– Extended Warranty, eCAL™ and Maintenance	32	Figure 7.9:	Standard sonde	27
9.1	Product Registration and Extended Warranty	32	Figure 7.10:	Super small sondes	27
9.2	Centros™ Manager	32	Figure 7.11:	Sewer sonde	27
9.2.1	Installing Centros Manager	32	Figure 7.12:	FlexiTrace	27
9.3	eCAL™	32	Figure 7.13:	Using a submersible antenna	29
9.3.1	Using eCAL™ to validate the RD7000+	33	Figure 8.1:	Cable sheath fault-finding	31
9.3.2	Using eCAL™ to retrieve the original factory calibration certificate	33	Figure 8.2:	Locating cable sheath faults with the locator and A-Frame	31

Section 1 – Introduction

1.1 About this manual

This manual provides cable and pipe survey professionals with comprehensive operating instructions for the RD7000+ locator and transmitter system. Before operating the RD7000+ system it is very important that you read this manual, noting all safety warnings and procedures.

1.1.1 Additional documentation

This manual introduces the Centros Manager software suite but provides only limited installation and operating instructions. The complete Centros Manager manual is available to download from www.radiodetection.com.

1.2 About the RD7000+

The RD7000+ system provides cable and pipeline locators with a fast, effective means of locating and mapping buried utilities.

The RD7000+ product family includes four powerful locators, and three transmitters offering one, three or ten watt power output. Each transmitter and locator is compatible with the relevant existing RD7000/RD8000/RD4000 accessories.

The RD7000+ locator is ergonomically designed to provide the operator with a balanced, light weight tool that encourages extended use in most environments.

1.3 Manual outline

The rest of this section provides an overview of safety procedures and notices. Please review them before moving on to Section 2 and the rest of this manual

Section 2 provides an overview of the RD7000+ system with annotated diagrams of the locator and transmitter

Section 3 introduces basic setup and operation using the RD7000+'s menu system.

Section 4 introduces the theory and practice of cable and pipe location using the RD7000+ locator and transmitter.

Section 5 introduces depth and current readings.

Section 6 provides general locating tips.

Section 7 introduces the range of accessories that are compatible with the RD7000+.

Section 8 introduces cable sheath fault-finding using the

RD7000TL+ and PL+ models and an accessory A-frame.

Section 9 provides information on extended warranty, remote product validation and maintenance advice

Section 10 includes several appendices with reference material and other technical information.

1.4 Safety

Please read this manual in its entirety before attempting to operate the RD7000+ locator or transmitter. Note all safety notices in the preface and throughout this manual.

Follow your company and national safety procedures and or requirements when operating this equipment in any environment or workplace. If you are unsure what policies or procedures apply, contact your company or site's occupational health and safety officer or your local government for more information.

Do not use this equipment if you suspect that any component or accessory is damaged or faulty.

Use authorized accessories only. Incompatible accessories may damage the equipment or give inaccurate readings.

Keep this equipment clean and arrange for regular services with an authorized Radiodetection service center. More information can be found in section 9 or from your local Radiodetection representative.

Do not attempt to open or dismantle any part of this equipment unless directed specifically by this manual. Doing so may render the equipment faulty and may void the manufacturer's warranty.

Figure 2.1: RD7000+ locator

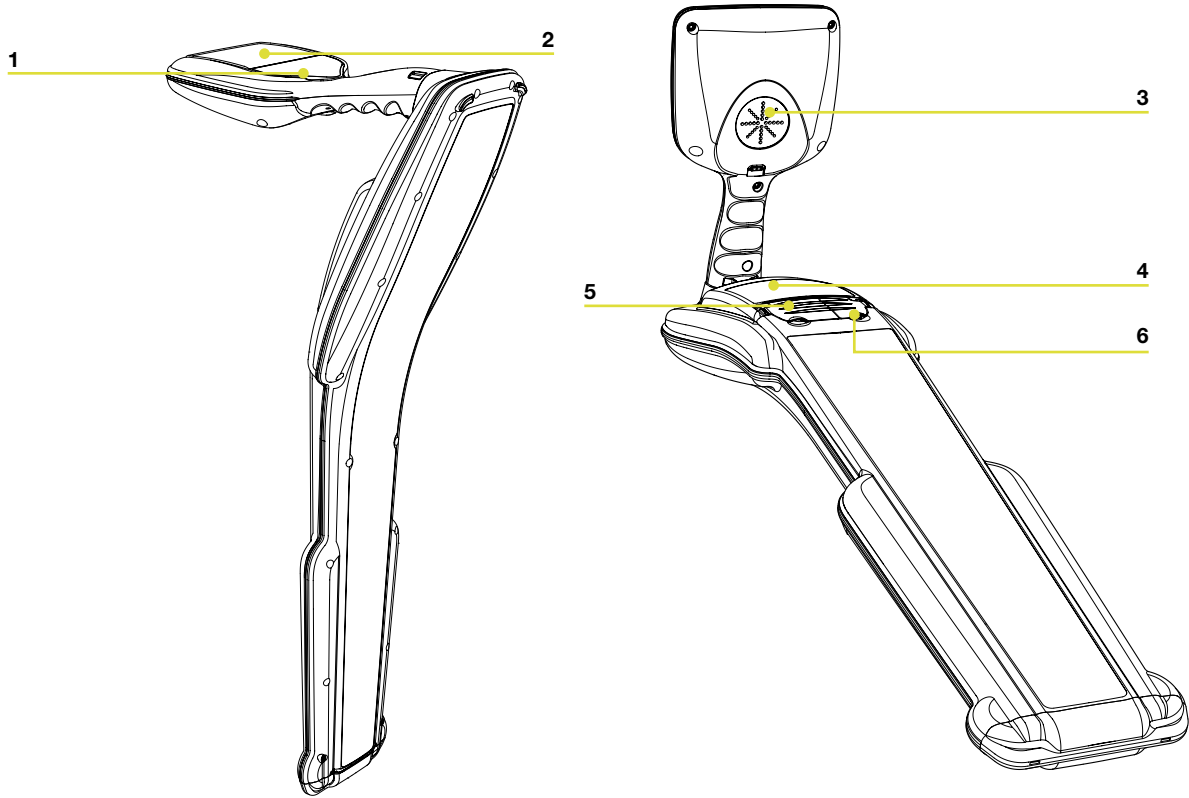

Figure 2.2: locator keypad

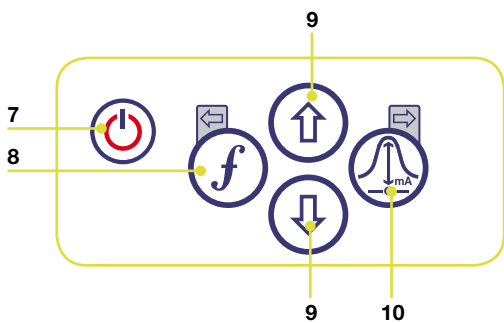
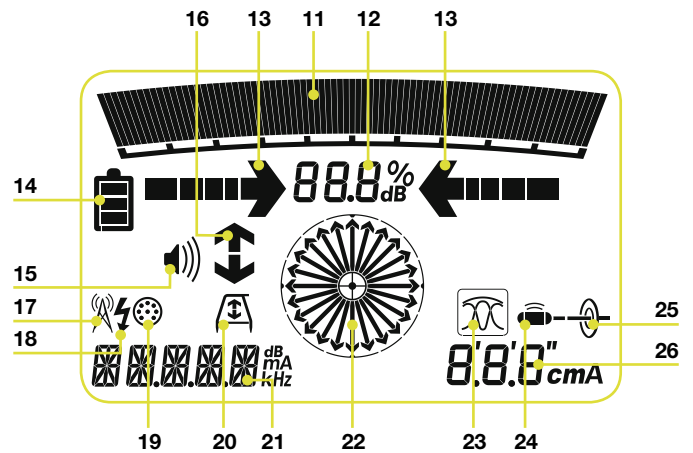

Figure 2.3: locator LCD







Section 2 – System overview

2.1 RD7000+ locator

2.1.1 Locator features

1. Keypad.
2. LCD with auto backlight.
3. Speaker.
4. Battery compartment.
5. Accessory slot.
6. Headphone jack.
22. Compass: Shows the direction of the located cable relative to the locator.
23. Null / Peak icon: Indicates antenna selection.
24. Sonde icon: Indicates that the signal source is from a sonde.
25. Line icon: Indicates that the signal source is from a line.
26. Current / depth indicator.

2.1.2 Locator keypad

7. Power key : Switches the unit on and off. Opens the locator menu.
8. Frequency key : Selects frequency. Closes submenu.
9. Up and down arrows  : Adjusts the signal gain. Scrolls through the menu options.
10. Antenna key : Toggles peak, null (PL and TL models only) and combined peak/null modes. Open submenu. Prolonged keypress toggles between depth or current display on the LCD.

2.1.3 Locator screen icons

11. Indicates the signal strength and peak marker.
12. Signal strength: Numeric indication of signal strength.
13. Peak arrows: Indicates the location of the line relative to the locator.
14. Battery icon: Indicates the battery level.
15. Volume icon: Displays the volume level.
16. Fault-Find arrows (PL and TL models only)
17. Radio Mode: Indicates when Radio Mode is active.
18. Power Mode: Indicates when Power Mode is active.
19. Accessory indicator: Indicates when an accessory is connected.
20. A-Frame icon: Indicates when the A-Frame is connected.
21. Operating mode indicator.

Figure 2.4 RD7000+ transmitter

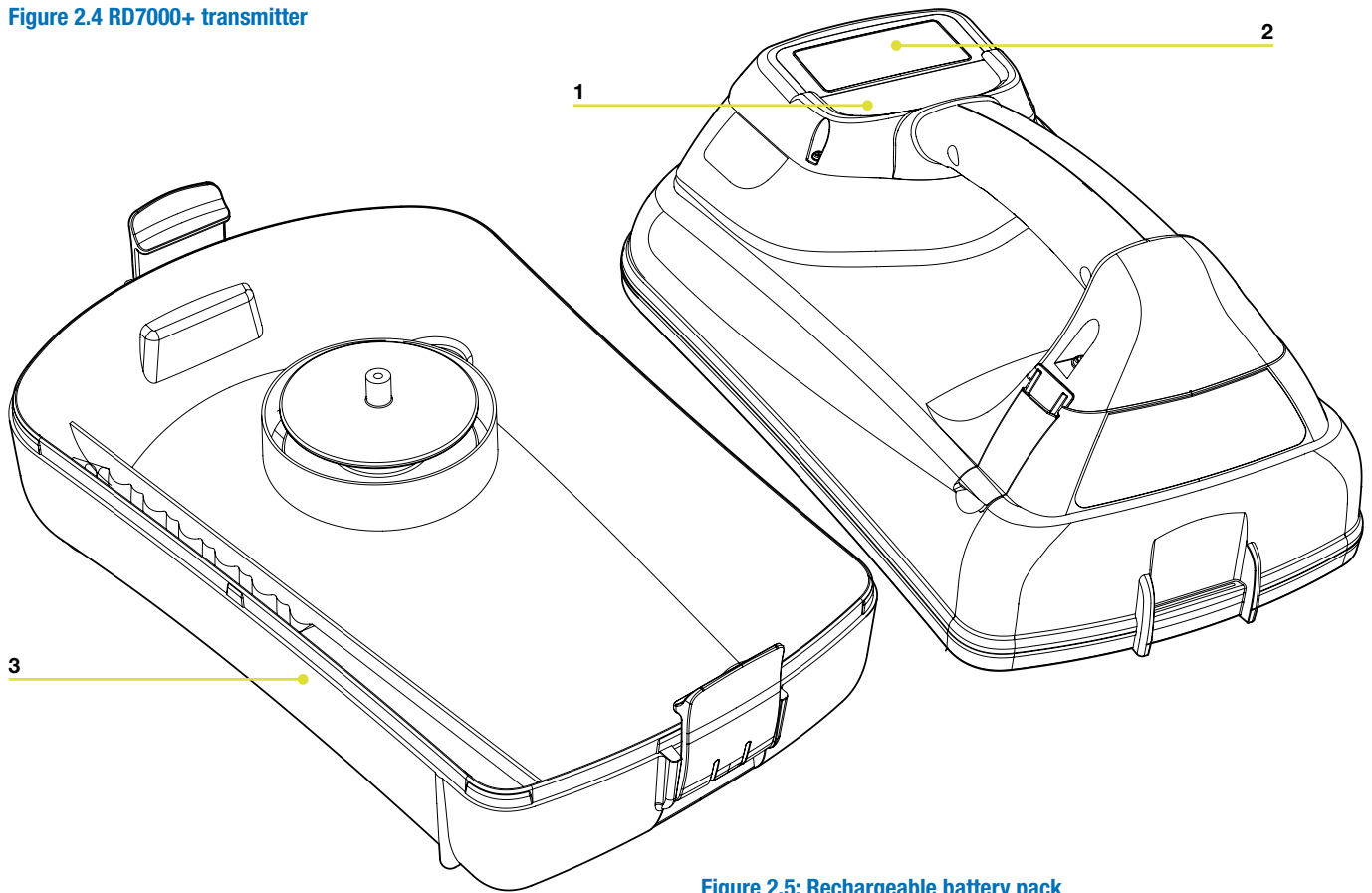

Figure 2.5: Rechargeable battery pack

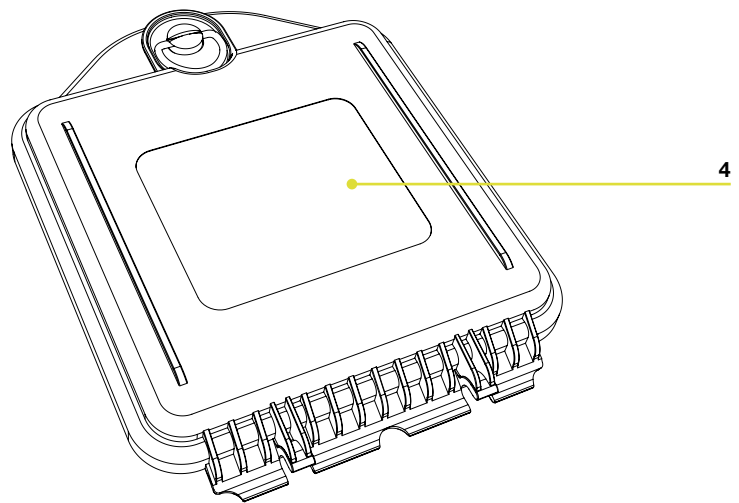

Figure 2.6: transmitter keypad

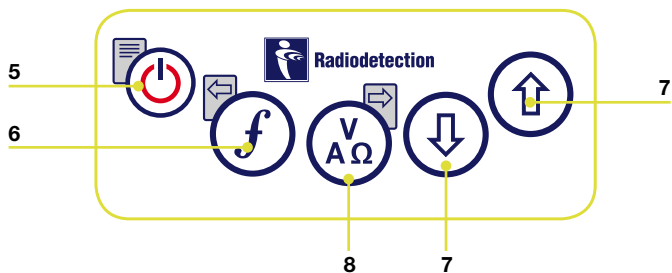
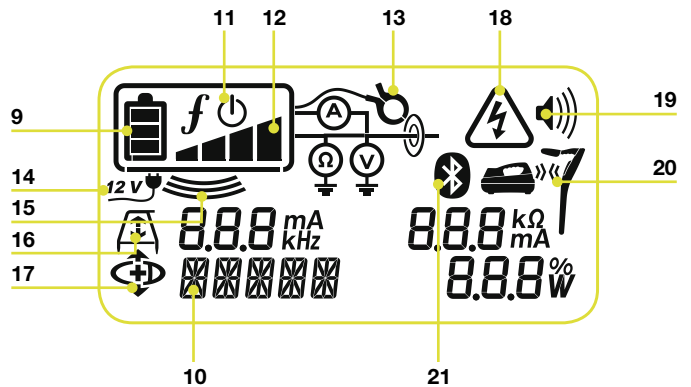

Figure 2.7 transmitter LCD







2.2 Tx-1, Tx-3 and Tx-10 transmitters

2.2.1 Transmitter features

1. Keypad.
2. LCD.
3. Removable accessory tray.
4. Rechargeable battery pack.

2.2.2 Transmitter keypad

5. Power key : Switches the unit on and off. Opens the transmitter menu.
6. Frequency key : Selects frequency. Menu navigation key.
7. Up and down arrows  : Adjusts the output signal. Scrolls through the menu options.
8. Measure key : Toggles measurement display between volts, current and impedance.

Note: displayed measurements are based on the currently selected mode or the attached accessory, if applicable. Opens a submenu.

2.2.3 Transmitter screen icons

9. Battery icon: Indicates the battery level.
10. Alphanumeric description of selected operation mode.
11. Standby icon: Appears when the transmitter is in Standby Mode.
12. Output level: Displays transmitter output power.
13. Clamp icon: Indicates when a clamp or other plug is connected.
14. DC icon: Appears when the transmitter is powered from a DC source.
15. Induction indicator: Appears when the transmitter is in Induction Mode.
16. A-Frame (Tx-3 and Tx-10 only): Indicates when the transmitter is in Fault-Find Mode.
17. CD Mode indicator (Tx-10 only): Indicates that the transmitter is in Current Direction Mode.
18. Voltage warning indicator: Indicates that the transmitter is outputting potentially hazardous voltage levels.
19. Volume icon: Displays the volume level.
20. Pairing icon (Tx-3B and Tx-10B only). For use with RD8000 locators only.
21. *Bluetooth*[®] icon (Tx-3B and Tx-10B only). For use with RD8000 locators only.

Section 3 – Basic operation

3.1 Starting the system

The locator and transmitter are battery powered. Install good quality D-cell (LR20) NiMH or Alkaline batteries into the locator and transmitter battery compartments or install the appropriate rechargeable battery pack. Alternatively, you can power the transmitter from a mains or vehicle power source using a Radiodetection supplied adapter.

To switch the locator or the transmitter on, press and hold the keypad Power Key for two seconds. When you switch the system on it will perform an LCD segment check. It will then display the model number followed by the software version. This information is important if you need to contact Radiodetection technical support or update your locator to the latest software.

NOTE: Once the system is switched on, pressing the Power Key momentarily will activate the locator or transmitter menu.

3.1.1 D-cell (LR20) Batteries

The LCD provides a battery level indicator (refer to the diagrams in Sections 2.1 and 2.2). When battery replacement is necessary, the LCD shows a flashing battery icon. The expected alkaline battery life under normal working conditions is approximately 30 hours on the locator and 15 hours on the transmitter.

NOTE: Prolonged use of high power output on the transmitter will reduce battery life.

To replace the batteries on the locator, unlatch the battery compartment cover, which is located above the accessory panel, and lower the tray. Remove the spent batteries and insert two D-Cell Alkaline or Ni-Cad batteries.

To replace the batteries on the transmitter, unlatch the accessory tray. The battery compartment is located underneath the transmitter body. Use the turnkey to unlatch the battery compartment. Remove the spent batteries and insert eight D-cell (LR20) Alkaline or Ni-Cad batteries.

NOTE: When installing batteries always observe the correct battery polarity as indicated on the battery tray.

3.1.2 Rechargeable battery packs

An optional NiMH Rechargeable battery pack is available for the RD7000+ locator. This pack is interchangeable with other Radiodetection Precision Locators that use 2 D-cell (LR20) batteries.

An optional Lithium Ion rechargeable battery pack is also available for the RD7000+ Tx1, Tx3 and Tx10 transmitters.

The rechargeable battery packs provide an estimated 8-hour working time, depending on use.

Rechargeable battery packs are available in kits that include the rechargeable battery pack and an AC adapter or 12V vehicle adaptor.

The battery packs must be removed from their parent units before connecting to a power source for recharging. For more information, refer to the instructions that came with your charger.

⚠ CAUTION! Do not heat the rechargeable battery pack above 60°C (140°F) as this will damage their thermal fuses.

NOTE: The batteries are designed to protect against over discharge, overcharge and short circuit between charge terminals.

Contact your local Radiodetection representative for information on purchasing battery packs and chargers.

3.2 System setup

It is important that you set up the system according to your personal preferences and operating requirements before you conduct your first survey. You can set the system up using the RD7000+ menu as described below.

NOTE: These procedures refer to both the transmitter and locator unless stated otherwise.





Before changing settings, ensure the locator or transmitter is switched on by pressing the key for two seconds.

3.2.1 Power frequency (locator only)

Select the correct frequency (50 or 60Hz) for your country or region's national power supply.

7







To change power frequency on the locator:

1. Press the  key momentarily to enter the menu.
2. Scroll to the POWER option using the arrow keys.
3. Press the antenna key to enter the POWER submenu.
4. Scroll up or down using the  or  arrows to select the correct frequency.
5. Press the  key to accept your selection and return to the main menu.
6. Press the  key to return to the main operation screen.

3.2.2 Language

The locator and transmitter support a number of languages. You can specify your preferred language using the menu system.





To select your preferred menu language:

1. Press the  key momentarily to enter the menu.
2. Scroll to the LANG option using the arrow keys.
3. Press the antenna key () on the transmitter) to enter the LANG submenu.
4. Scroll up or down using the  or  arrows to select your preferred language.
5. Press the  key to accept your selection and return to the main menu.
6. Press the  key to return to the main operation screen.

3.2.3 Units (locator only)

The RD7000+ allows you to work in Metric or Imperial (US customary) units.





To select your preferred units of measurement:



1. Press the  key momentarily to enter the menu.
2. Scroll to the UNIT option using the arrow keys.
3. Press the antenna key to enter the UNIT submenu.
4. Scroll up or down using the  or  arrows to select Metric or Imperial units.
5. Press the  key to accept your selection and return to the main menu.
6. Press the  key to return to the main operation screen.

3.2.4 Battery type

The RD7000+ locator and transmitter support both NiMH or Alkaline D-cell (LR20) replaceable batteries, or can be fitted with an optional rechargeable battery pack, which is Lithium-Ion type for the transmitter and NiMH type for the locator. It is important that you set the system to match the currently installed battery type to ensure optimal performance and correct battery level indication.



To set your battery type:

1. Press the  key momentarily to enter the menu.
2. Scroll to the BATT option using the  or  arrows.
3. Press the antenna key () on the transmitter) to enter the BATT submenu.
4. Scroll up or down to select the correct battery type.





5. Press the  key to accept your selection and return to the main menu.
6. Press the  key to return to the main operation screen.

The RD7000+ is now ready to use.

3.3 Using the menu

The RD7000+ locator and transmitter menus allow you to select or change system options. Once entered, the menu is navigated using the arrow keys. Navigation is consistent on both the transmitter and the locator. When in the menu, most on-screen icons will temporarily disappear and the menu options will appear in the bottom left-hand corner of the LCD. Note that when browsing the locator menu, the  and antenna keys act as left and right arrows. When browsing the transmitter menu the  and  keys act as left and right arrows. The right arrow enters a submenu and the left arrow returns to the previous menu.

3.3.1 Navigating the locator menu







1. First power up the locator.
2. Press the  key to enter the menu.
3. Use the  or  arrows to scroll through the menu options.
4. Press the antenna key to enter the option's submenu.
5. Press the  key to return to the previous level.
6. Press the  key to return to the main operation screen.

3.3.2 Locator menu options

Below is an annotated list of menu options that are available under the main menu of the RD7000+ locator.

- VOL: Adjust the speaker volume from 0 (mute) to 3 (loudest).
- UNIT: Select metric or imperial units.
- LANG: Select your preferred system language.
- POWER: Select the relevant national power frequency: 50 or 60Hz.
- FREQ: Enable or disable individual frequencies.
- ALERT: Enable or disables StrikeAlert™.
- BATT: Sets battery type. NiMH or ALK.
- ANT: Enable or disable any antenna mode with the exception of Peak.
- CAL: Displays the date of original factory calibration

3.3.3 Navigating the transmitter menu

1. First power up the transmitter.
2. Press the  key to enter the menu.
3. Use the  or  arrows to scroll through the menu options.
4. Press the  key to enter the option's submenu.
5. Press the  key to return to the previous level or exit the menu.
6. Press the  key to return to the main operation screen.



Transmitter menu option

- VOL: Adjust the speaker volume from 0 (mute) to 3 (loudest).
- BT: Enable, disable or pair *Bluetooth*® connections (Tx-3B and Tx-10B only).
- MAX V: Set the maximum output voltage.
- MODEL: Specify the model of your RD7000+ locator.
- MAX P: Allows the transmitter to output its maximum wattage.
- BATT: Set battery type. NIMH or ALK or LI-ION.
- OPT F: Enable or disable *SideStepauto*™.
- LANG: Select the transmitter system language.
- BOOST: Boost transmitter output for a specified period of time (in minutes).
- FREQ: Enable or disable individual frequencies.

3.4 Shutting down

To switch the locator or the transmitter off, press and hold the  key for two seconds.

NOTE: The locator will automatically power off if no keys are pressed after a five minute duration.

3.5 Headphones

Radiodetection supplies an optional headphone set for the RD7000+ locator. The headphones feature an adjustable headband to ensure a tight fit when used in the field. The accessory headphones also feature volume adjustment for both left and right speakers.

Connect the 3.5mm headphone jack into the locator's headphone socket, which is located next to the accessory panel on the front of the locator.

NOTE: Before wearing headphones, lower the locator's volume levels to help prevent damage to your hearing.

 **WARNING!** Wearing headphones may impede your awareness to dangers in the field such as moving traffic or other heavy machinery. Exercise caution!

3.6 Frequencies

The RD7000+ supports a large range of locatable active and passive frequencies. For a complete list of supported frequencies, please refer to the table in Appendix 10.2.

3.6.1 Passive frequencies

Passive frequency detection takes advantage of signals that are already present on buried metallic conductors. The RD7000+ range supports up to three types of passive frequencies: Power, Radio and Cathodic Protection System (CPS, RD7000DL+ only) signals. You can detect these frequencies without the aid of a transmitter if they are present on the utility you are surveying.

3.6.2 Active frequencies

Active frequencies are applied direct to a buried conductor using the transmitter. The transmitter can apply a signal using two methods: induction and direct connection.

Induction

The transmitter is placed on the ground over or near the survey area. You select the appropriate frequency. The transmitter will then induce the signal indiscriminately to any nearby metallic conductor. In induction mode, using higher frequencies is generally recommended as they are induced easier onto nearby conductors.

Direct connection

In direct connection, you connect the transmitter directly to the pipe or cable you wish to survey. The transmitter will then apply a discreet signal to the line, which you can locate using the locator. This method provides the best signal on an individual line and enables the use of lower frequencies, which can be traced for longer distances.

Connecting the transmitter to a pipe or line requires the use of a direct connection lead or clamp and a ground stake to complete the circuit. For more information about signal clamps and other direct connection accessories, please refer to Section 7.

 **WARNING!** Direct connection to live wires is **POTENTIALLY LETHAL**. Direct connections should be attempted by fully qualified personnel only!

 **WARNING!** The transmitter is capable of outputting potentially lethal voltages. Take care when handling the terminals, connection leads and ground stake, notify other technicians working on the line of



the hazard and guard exposed conductors to prevent accidental contact.

3.6.3 Selecting frequencies

It is important to select the correct or appropriate frequency for your particular application. For more information see Section 6 or refer to the “ABC & XYZ of locating buried pipes and cables”, which is available as a free download from www.radiodetection.com.





To select a frequency on the locator:

1. Switch the unit on by pressing the  key, if you have not already done so.
2. Press the  key to cycle through available frequencies.
3. Alternatively, hold down the  key and press the up or down arrows to cycle up or down the range of frequencies.

If using an active frequency you must also set your transmitter to output the matching frequency. You can change your transmitter’s output frequency manually using your transmitter’s keypad or automatically using iLOC (iLOC enabled locators and transmitters only).



To manually select a transmitter output frequency:

1. Switch the unit on by pressing the  key, if you have not already done so.
2. Press the  key to cycle through available frequencies.

NOTE: Some frequencies require that you connect an accessory, for example an A-Frame, before the frequency is available.

3.7 TruDepth™ measurement

The RD7000+ uses TruDepth to automatically estimate depth when a good reading is established.

NOTE: TruDepth only indicates a locate depth when the locator is correctly oriented directly above the detected pipe or cable.

To help you orient the locator correctly, you can use the locator’s compass on the LCD screen

Depth readings are displayed according to your preferred units of measurement as follows:

- Less than 1 meter: depth is displayed in centimeters.
- Greater than 1 meter: depth is displayed in meters.
- Less than 3 feet: depth is displayed in inches.
- Greater than 3 feet: depth is displayed in feet.

For more information on measuring depth, please refer to Section 5.

3.8 SideStepauto™









SideStepauto allows the transmitter to calculate the optimum frequency based on ground impedance. The transmitter uses this information to optimize the active frequency. SideStepauto helps to improve locate accuracy by determining the best signal. SideStepauto can also help to prolong battery life.

NOTE: SideStepauto will only work in direct connection mode. Inductive frequencies are not supported.











3.8.1 Using SideStepauto

To enable SideStepauto

1. Switch on the transmitter.
2. Press the  key to enter the menu.
3. Scroll to the OPT F option using the  or  arrows.
4. Press the  key to enter the OPT F menu.
5. Scroll to the START option using the  or  arrows.
6. Press the  key to start SideStepauto and exit the OPT F menu.
7. Press the  key to exit the menu.



To disable SideStepauto

1. Switch on the transmitter.
2. Press the  key to enter the menu.
3. Scroll to the OPT F option using the  or  arrows.
4. Press the  key to enter the OPT F menu.
5. Scroll to the EXIT option using the  or  arrows.
6. Press the  key to disable SideStepauto and exit the OPT F menu.
7. Press the  key to exit the menu.

3.9 Dynamic Overload Protection









The RD7000+ range features Dynamic Overload Protection (DOP). DOP allows you to locate accurately in areas with high levels of electromagnetic interference, such as sub-stations and beneath high-voltage transmission lines. DOP works by disregarding signal spikes that would otherwise overwhelm the RD7000+’s digital signal processor. DOP is an integrated feature of the RD7000+ range. No action is required by the user to enable it.

3.10 StrikeAlert™









StrikeAlert detects shallow pipes or cables and warns the operator with an audible alarm and visual display. The alarm is characterized by a rapid warbling sound and a flashing operating mode indicator. StrikeAlert is enabled by default; you can enable and disable StrikeAlert using the procedure detailed below.

NOTE: StrikeAlert will not sound when the locator's volume is muted.

To disable StrikeAlert

1. Switch on the locator.
2. Press the  key to enter the menu.
3. Scroll to the ALERT option using the  or  arrows.
4. Press the  key to enter the ALERT menu.
5. Scroll to the OFF option using the  or  arrows.
6. Press the  key to disable StrikeAlert and exit the ALERT menu.
7. Press the  key to exit the menu.

To enable StrikeAlert

1. Switch on the locator.
2. Press the  key to enter the menu.
3. Scroll to the ALERT option using the  or  arrows.
4. Press the  key to enter the ALERT menu.
5. Scroll to the ON option using the  or  arrows.
6. Press the  key to enable StrikeAlert and exit the ALERT menu.
7. Press the  key to exit the menu.

3.10.1 Using StrikeAlert

StrikeAlert works with passive power frequencies only.

When StrikeAlert is active, it will automatically sound when a shallow pipe or cable is detected.

3.11 Antenna modes

The RD7000+ locator range supports up to three antenna modes (depending on model) to suit your particular application or the local environment. These modes are:

- Peak mode (all models).
- Null mode (PL and TL models only).
- Combined Peak/Null mode (all models).

For more information on selecting and using the various antenna modes to assist with cable and pipe location, please refer to Section 4.1.

3.12 Backlight

The transmitter and locator feature a backlight to improve LCD visibility when required. The locator's backlight is controlled by an ambient light sensor and does not require adjustment by the user.









The transmitter's LCD backlight is activated whenever you press a key. The backlight will automatically switch off after a few minutes and will reactivate when any button is pressed.

3.13 Audio









The transmitter and locator feature an internal speaker to provide critical warnings or assist with cable and pipe location. The transmitter by default will also sound a pulsing tone to indicate that it is transmitting correctly.

To adjust locator audio:

⚠ WARNING! Muting audio on the locator will disable StrikeAlert.

1. Switch on the locator.
2. Press the  key to enter the menu.
3. Scroll to the VOL option using the  or  arrows.
4. Press the  key to enter the VOL menu.
5. Use the  or  arrows to select the desired volume level where 0 is mute and 3 is loudest.
6. Press the  key to accept the change and exit.
7. Press the  key to exit the menu.

To adjust transmitter audio levels:

1. Switch on the transmitter.
2. Press the  key to enter the menu.
3. Scroll to the VOL option using the  or  arrows.
4. Press the  key to enter the VOL menu.
5. Use the  or  arrows to select the desired volume level where 0 is mute and 3 is loudest.
6. Press the  key to accept the change and exit.
7. Press the  key to exit the menu.



3.14 Transmitter power output

The transmitter supports several power output modes to help you select the optimal settings for your requirements whilst helping to prolong battery life.

3.14.1 Adjusting power output



To adjust the power output:

1. Switch on the transmitter.
2. Press the  or  keys to increase or decrease power output.









3.14.2 Boost (Tx-3 and Tx-10 only)

Boost allows the transmitter to output its maximum wattage for a specified period of time in minutes.

⚠ WARNING! The transmitter is capable of outputting potentially lethal wattages. Exercise extreme caution when using Boost.

To configure boost:



1. Switch on the transmitter.
2. Press the  key to enter the menu.
3. Scroll to the BOOST option using the  or  arrows.
4. Press the  key to enter the BOOST menu.
5. Set the BOOST duration using the  or  arrows. You can choose 5, 10, 15 and 20 minute periods.
6. Press the  key to accept your changes and exit the BOOST menu.
7. Press the  key to exit the menu.

To enable boost:

1. First configure the boost duration using the procedure above.
2. Press and hold the  arrow until BOOST appears on the transmitter LCD.
3. The transmitter will automatically exit boost mode after the allotted duration.

To disable boost:

1. Press and hold the  arrow to switch boost off.

Section 4 – Locating cables and pipes

This section introduces the principals and techniques of locating buried cable and pipe utilities with the RD7000+ system. For more information on the theory of cable and pipe location, please refer to “*ABC & XYZ of locating buried pipes and cables*”, which is available from www.radiodetection.com

4.1 Antenna modes

The RD7000+ system supports three antenna modes to suit your particular application or the local environment. These modes are:

- Peak mode (all models)
- Null mode (TL and PL models only).
- Peak/Null mode (all models).



4.1.1 Peak mode

Peak mode provides the most sensitive and accurate mode for location and depth measurement. It provides a sharp peak response with a corresponding small decrease in sensitivity. Peak mode is always enabled unless an alternative mode is selected using the menu.

In peak mode the following indicators are displayed by the LCD:

- Depth.
- Current.
- Signal strength.
- Compass.

To select a peak mode:

1. Press and release the  key to switch the locator on.
2. Press the antenna key until the peak mode icon  is displayed on the LCD.



4.1.2 Null mode

Null mode is used to verify a locate signal in environments with limited or no electromagnetic distortion.

In null mode the following indicators are displayed by the LCD:

- Signal strength.
- Right and left arrows.
- Compass.

To select null mode:

1. Press and release the  key to switch the locator on.
2. Press the antenna key until the null mode icon  is displayed on the LCD.

Null mode gives a null response when it is directly over the line. The sharp, null response is easier to use than the peak response but is vulnerable to interference and should not be used for locating, except in areas where there is no interference present (See 4.1.3 Combined Peak/Null mode). In null mode, the locator will indicate line position but not its orientation.

4.1.3 Combined Peak/Null mode

Peak/Null mode give you the advantages associated with these modes simultaneously.

Use the proportional arrows to place the locator above the NULL point. If the peak response is not at a maximum then this is evidence of a distorted field. If the peak response is at its maximum level where the NULL point is located then there is no or very limited distortion present.

In Peak/Null mode the following indicators are displayed by the LCD:

- Proportional right and left arrows.
- Signal strength.
- Current
- Depth
- Compass

To select Peak/Null mode:

1. Press and release the  key to switch the locator on.
2. Press the antenna key until the Peak/Null mode icon is displayed on the LCD.

4.2 Compass

The LCD compass provides a visual indication of the direction of the target cable, pipe or sonde. The compass is available when locating active frequencies as well as CATV and CPS passive frequencies. The compass is unavailable when the locator is set to detect passive Power and Radio signals.

4.3 Trace

Line tracing can be accelerated by switching the locator to null response.

Move the locator left and right while walking along the path of the line to observe the null directly over the line and a peak response to each side of the line. As you move the locator over the line, the left and right arrows (and an accompanying tone) will indicate if the target line is to the left or right of the locator.

Periodically switch to peak mode, locate the target line, and verify its exact position.

Figure 4.1 Line tracing

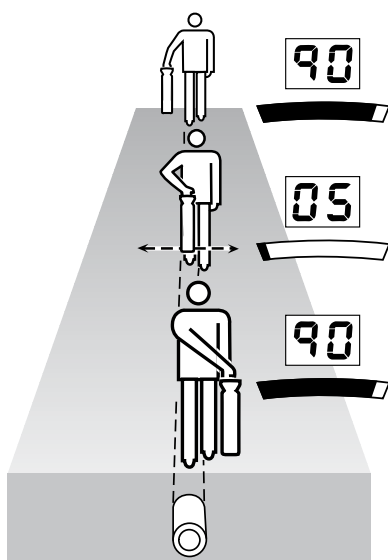

4.4 Pinpoint

Pinpointing a target line in peak mode, defines the exact position of a target line after it has been traced and its position is approximately known. Start with medium output power from the transmitter, medium frequency on the transmitter and locator, and peak mode on the locator.

Set the locator sensitivity to approximately 50%.

NOTE: it may be necessary to adjust the sensitivity level throughout the pinpointing to keep the bar graph on scale.

Figure 4.2: Pinpointing a target line

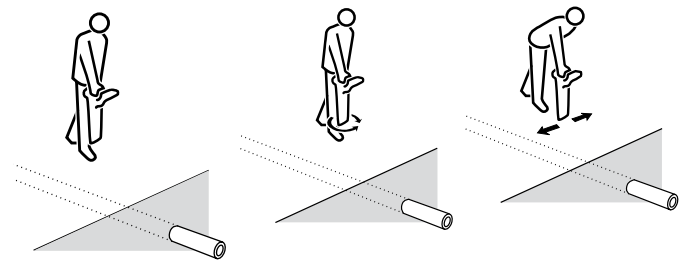
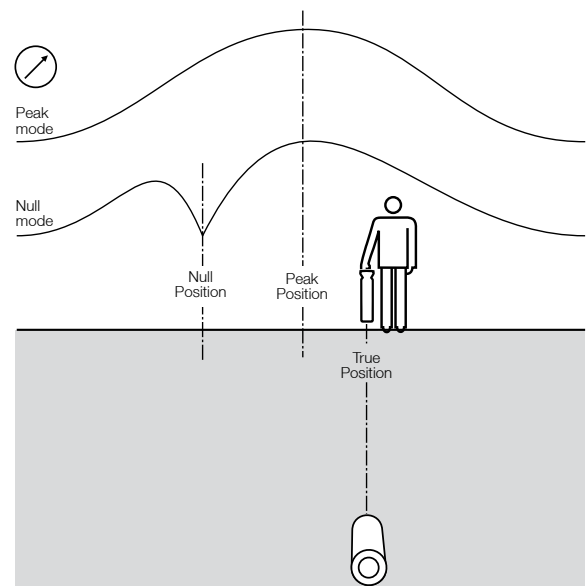

Figure 4.3: Pinpointing with Peak/Null



1. With the antenna perpendicular to the line, make traverses across the line. Define the point of maximum response.
2. Without moving the locator, turn it round as if it is on a pivot. Stop at the point of maximum response.
3. Hold the locator vertical with the antenna just above the ground and move the locator from side to side across the line. Stop at the point of maximum response.
4. With the end of the antenna close to the ground, repeat steps 2 and 3.
5. Mark the position and direction of the line.

Repeat the steps of the procedure to increase pinpoint accuracy.

Switch to null response mode and move the locator to find the null position. If the position of the peak and the null pinpoints correspond, it can be assumed that the pinpoint is precise. The pinpoint is not precise if the marks do not correspond, but both marks will show an error to the same side. True line position will be close to peak position.

The line lies half the distance to the other side of the peak position as the distance between the peak and the null positions.



4.5 Sweep and search

There are a number of techniques available for locating unknown lines in an area. Using these techniques is particularly important before conducting any excavation work to ensure that buried lines are not damaged.

4.5.1 Passive Sweep

A passive sweep will locate any Power, Radio or CPS (RD7000DL+ only) signals that may radiating from buried conductors.

To perform a passive sweep:

1. Press and release the  key to switch the locator on.
2. Press the  key to select the passive frequency you wish to locate. You can select from the following passive frequencies:
 - a. Power.
 - b. Radio.
 - c. CPS. (RD7000DL+ only).
3. Adjust the sensitivity to maximum; reduce the sensitivity to keep the bar graph on scale when there is a response.
4. Traverse the area in a grid search (Figure 4.4), at a steady walk, and hold the locator comfortably with the antenna in line with the direction of movement and at right angles to any lines that may be crossed.

7

Figure 4.4: Passive sweep

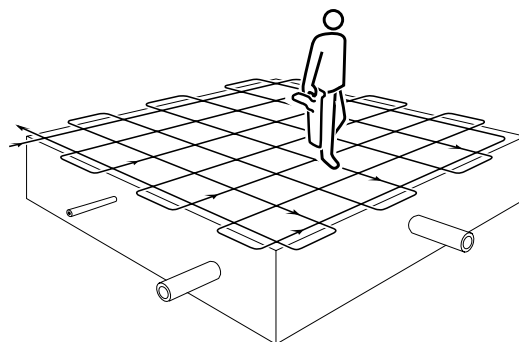

Stop when the locator response rises to indicate the presence of a line. Pinpoint the line and mark its position. Trace the line out of the area being searched. Resume grid search in the area.

In some areas there may be a confusing amount of 50/60Hz power signals. Lift the locator 50mm from the ground and continue the sweep.

Switch the locator to Radio Mode if the locator supports this feature. Increase sensitivity to maximum and repeat the above grid search procedure over the area. Pinpoint, mark, and trace out any lines that are located.

In most, but not all areas, radio mode will locate lines that do not radiate power signals and a grid search should be made in both power and radio modes.

4.5.2 Inductive search

An inductive search procedure is the most certain technique for locating unknown lines. This type of search requires a transmitter and locator and two people. This type of search is referred to as a 'two person sweep'. Before starting the sweep, define the area of search and the probable direction of lines crossing the area. Ensure the transmitter is switched on in induction mode.

The first person operates the transmitter and the second person operates the locator. The transmitter induces a signal onto lines as it passes over them and the lines are then detected with the locator 20 paces upstream or downstream of the transmitter. Hold the transmitter with its length aligned with the assumed direction of any lines.

Figure 4.5: Inductive search

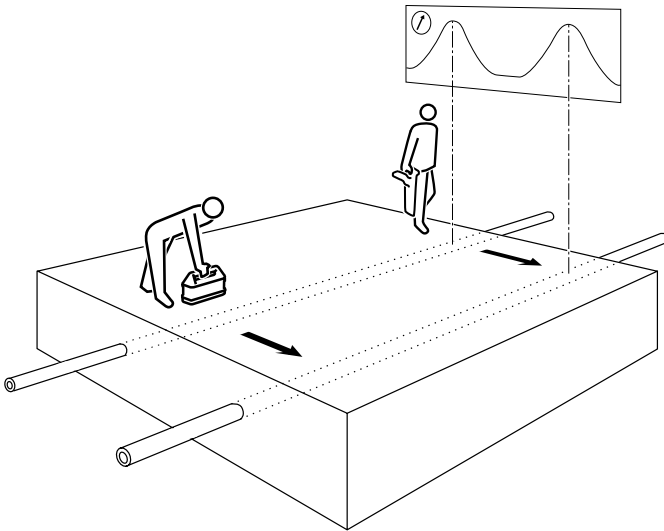

The second person holds the locator at the start of the area to be searched and with the locator antennae at right angles to the probable direction of the buried lines. Set the locator sensitivity level as high as possible without the locator picking up any airborne signals directly from the transmitter.

When the transmitter and locator are in line both operators start to move forward in parallel. The operator with the locator sweeps it backwards and forwards, keeping the locator vertical, as they proceed in parallel with the transmitter. This method allows for misalignment of the transmitter, locator and buried line.

The transmitter applies the strongest signal to the lines directly below it, which are then located with the locator. Move the transmitter from side to side to establish the highest signal which indicates that the transmitter is also directly above the line(s).

Mark the ground at the point of each peak signal detected with the locator. Repeat the search along any other possible paths of lines.

Once the positions of any lines have been marked, reverse positions, place the transmitter over and along each line in turn, and trace the line out of the search area.

Section 5 – Depth and current readings

5.1 Depth readings

The RD7000+ can measure the depth of buried conductors down to depths of approximately 6 meters (20 feet) for a line, or 15 meters (50 feet) when using a sonde. RD7000+ will locate to greater depths but accuracy may be reduced. The depth measurement is to the center of the pipe or cable. The best readings are detected from signals outputted by a transmitter rather than from passive sources.

The RD7000+ is capable of determining depth when locating passive power signals. However passive signals on lines are less suited for measuring depth because accuracy is questionable due to the passive signal being present on more than one line.

NOTE: The accuracy of depth measurement is subject to a number of factors and is meant as a guide only. Exercise caution when performing any excavation.

⚠ WARNING! Do not make depth measurements near bends or tees in the line. Go at least 5 meters from a bend for best accuracy.

5.1.1 TruDepth and Compass

It is important to note that the RD7000+ will only display depth when the locator is correctly oriented above the target line, cable or sonde. To ensure the locator is correctly oriented, use the LCD Compass:

When locating lines, make sure the Compass displays the line in the 6 o'clock position.

When locating sondes (see Section 10.4), make sure the Compass displays the line in the East / West position.

Figure 5.1: Taking a depth reading

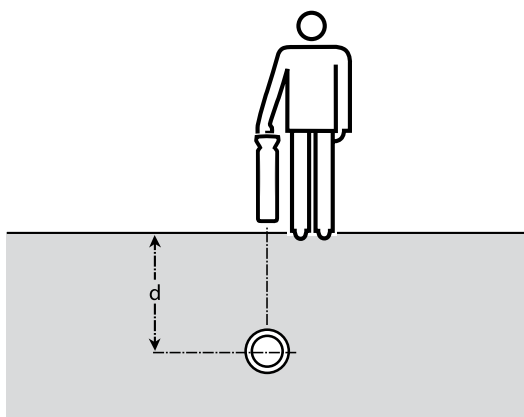

To avoid signal distortion, do not apply the signal by induction. If direct connection or signal clamping is not possible, place the transmitter at least 15 meters from the point of any depth measurements.

Depth measurements are not accurate if there is audible interference or if part of the transmitter signal has coupled to a nearby line.

Confirming the peak position coincides with a null position indicates that the position is suitable for making a depth estimate.

Figure 5.2: Depth readings

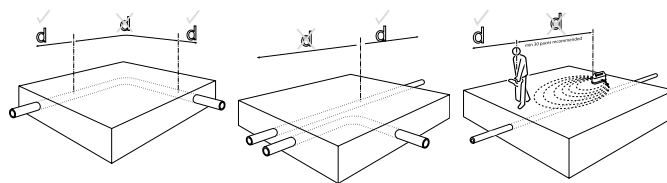

- Pinpoint the target line accurately with the locator.
- Check the locator is directly over the line, the antennae are at right angles to it and the locator is vertical. Adjust sensitivity level to bring the bar graph indication on scale.
- Press the depth button to toggle between depth and current readings.

If the ground appears to radiate a strong field, perhaps near a radio station, check depth by holding the bottom of the antenna 50mm above the ground and subtract this reading from the indicated depth.

5.2 Verifying depth measurements

Check a suspect or critical depth reading by lifting the locator 50mm (2 inches) above the ground and repeating the measurement. If the measured depth increases by the same amount it is a good indication that the depth reading is correct.

Depth measurements should be accurate to $\pm 5\%$ if conditions are suitable. However, you may not always know if the conditions are suitable so the following techniques should be used to check critical readings:

- Check that the route of the line is straight for at least 2 meters (6'6") to either side of the measurement point.
- Check that the signal response is reasonably constant over the 15 meter distance to the transmitter and make depth measurements to either side of the original point.
- Check that there are no adjacent lines carrying a significant signal within 1 to 2 meters of the target line. This is the most common source of error of depth measurements as a strong signal coupled to an adjacent line can often introduce $\pm 50\%$ error.
- Make several depth measurements at points slightly displaced from the line's apparent position. The shallowest indication will be the most accurate and will also indicate the line's position most accurately.

5.2.1 Rough depth calibration check

This check is a quick and easy way of verifying that the depth reading on the locator is within acceptable limits. It can be used if you are getting inaccurate depth readings from a cable or pipe for which you know the approximate depth. Inaccurate depth readings could be the result of the locator picking up a stronger signal such as another cable or pipe running in close parallel to the target pipe or cable.

There are two ways of checking the calibration of the locator in the field. Both methods require the use of a transmitter:

Method 1

Place the transmitter on top of a non-metallic object, such as a cardboard box, on the ground and away from any buried lines. Switch the transmitter on, ensuring that no accessories are connected and that the transmitter is in induction mode. To reduce the effects of ground coupling the transmitter, when it is placed on the box, must be more than 500mm above the ground

Hold the locator with the blade horizontal and pointing towards the front of the transmitter and approximately five meters from the front of the transmitter.

1. Switch the locator on.
2. Select the same induction frequency as is selected on the transmitter.
3. Select sonde mode on the locator.
4. Move the locator from left to right and when the maximum signal is obtained place the locator on top of a non-metallic object, such as a cardboard box, on the ground. Ensure that the blade is horizontal and pointing towards the transmitter. To reduce the effects of ground coupling the locator must be more than 500mm (18 inches) above the ground when it is placed on the box.
5. Note the depth as indicated on the locator.
6. Measure the distance from the base of the locator to the center of the transmitter using a tape measure.
7. Compare this reading with the depth reading on the locator.

The locator can be considered accurate if the difference between the depth reading on the locator and the distance measured with the tape is less than 10%.

Method 2

1. Apply a signal to a cable or pipe of known depth.
2. Locate the cable or pipe; the locator will show depth automatically.
3. Compare the depth reading on the locator with the actual depth.

5.3 Current readings

5.3.1 Identification using current measurements

Measuring current value on a line helps confirm the identity of the line and provides information about the condition of cable insulation or pipe coating.

5.3.2 About current measurements

The transmitter applies a signal or current onto a target line. The current decreases in strength as the distance from the transmitter increases. This rate of decrease depends on the type of line and on soil conditions. Regardless of the type of line and the frequency being used the rate of decrease should be regular with no sudden drops or changes. Any sudden or abrupt current change indicates that the line or its condition has changed.

In congested areas, where there is more than one line, the locator may sometimes detect a stronger signal from an adjacent line to which the signal has coupled or shares common grounding because it is nearer the surface. Although current measurement compensates for depth, signal response will be less as the depth increases.

The line with the highest current measurement, rather than the line giving the strongest response, is the target line to which the transmitter signal has been applied.

Measuring current provides useful information about the position of bends and intersections. Measuring current after a tee will indicate the main line that pulls more current along its greater length.

Figure 5.3: Current readings

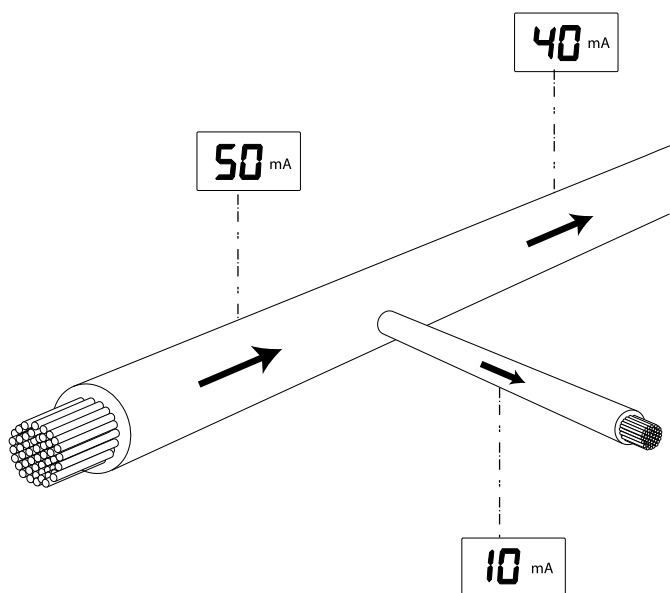

Figures 5.4 – 5.6: Taking current readings

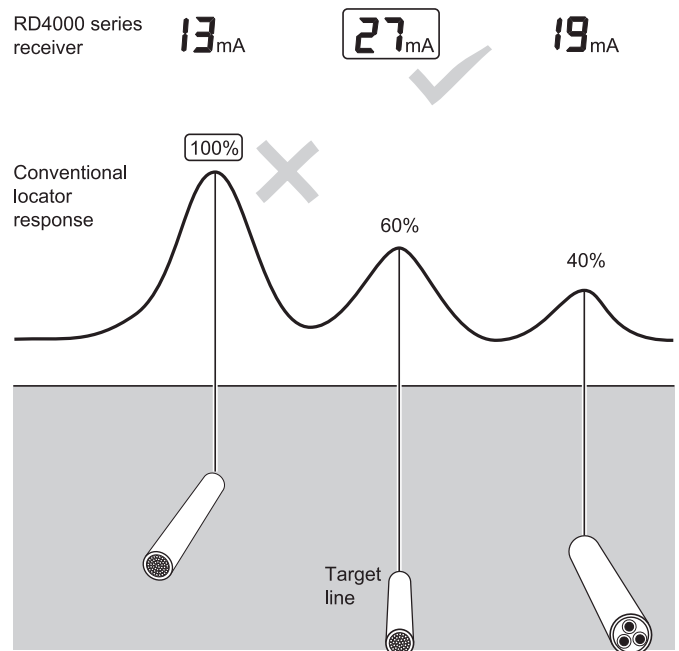
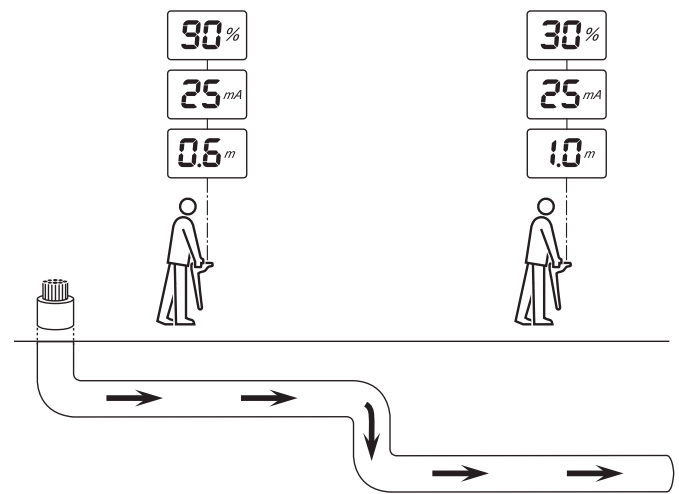
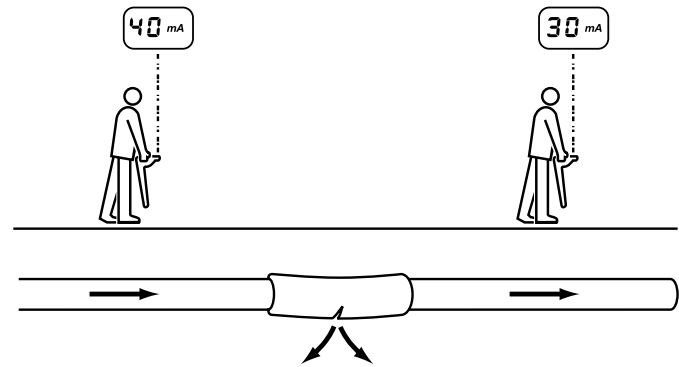

5.3.3 Applying a transmitter signal

The transmitter signal can be connected, clamped or induced to the target line in the same way as the signal for line tracing is applied.

5.3.4 Signal current measurements

Pinpoint the line and confirm the accuracy of the peak pinpoint with a null pinpoint. Check the locator is directly over the line, with the antennae at right angles to it and vertical.

The locator will automatically estimation and display the depth reading on the LCD.

A signal coupled to a nearby line may distort the accuracy of the measurement. If the accuracy of the reading is suspect, sweep the area to check if other nearby lines are radiating the signal. If other signals are causing interference, it may be necessary to make the current measurement at another point along the line.

Both antennae are needed to make a current measurement and locator accessory antennae such as a normal clamp or stethoscope cannot be used. Because current measurement is a function of depth, it is only available in the locating modes.

Figure 5.7: Current readings using transmitter signals

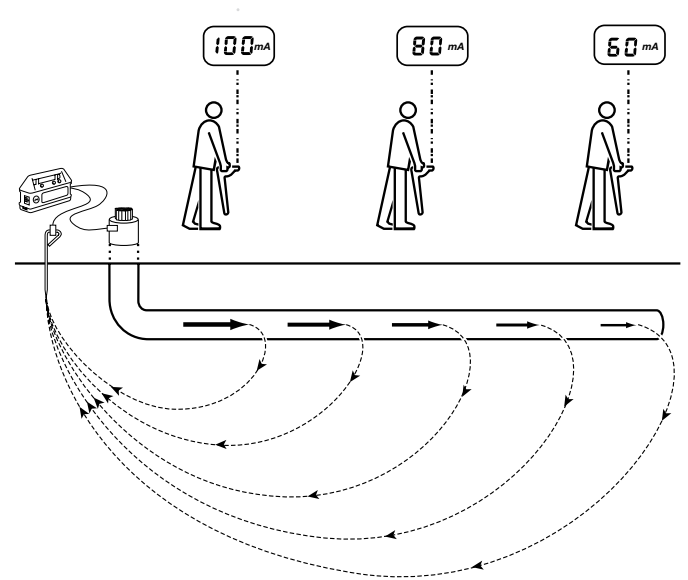

Section 6 – General Locating tips

6.1 Eliminating services

6.1.1 Induction

If several conductors are running parallel and it is not possible to connect a transmitter, each line may be located separately. Proceed as follows:

1. Perform a sweep of the area to find the position and number of conductors in the area.
2. Map the direction in which the conductors are going.

To trace the lines:

1. Select induction mode on the transmitter.
2. Select the same frequency as on the locator.
3. Place the transmitter on its side and in line with a conductor.
4. Ensure the conductor is directly below the transmitter.
5. This will null the signal directly below the transmitter and, in addition, enable the other conductors to be located.
6. Locate each conductor and mark its position.
7. Move the transmitter down the route and continue locating and marking.
8. Trace each conductor out of the search area until the target line can be accurately located.

6.1.2 Unwanted signal coupling

Unwanted coupling of the signal from the target line to another nearby line is one of the most common location problems. It leads either to an error in the marked position and depth of the target line or to marking the wrong line. A certain degree of coupling is unavoidable in many situations but there are ways in which a careful user can reduce coupling and increase location reliability.

Figures 6.1 – 6.4: Interference from services

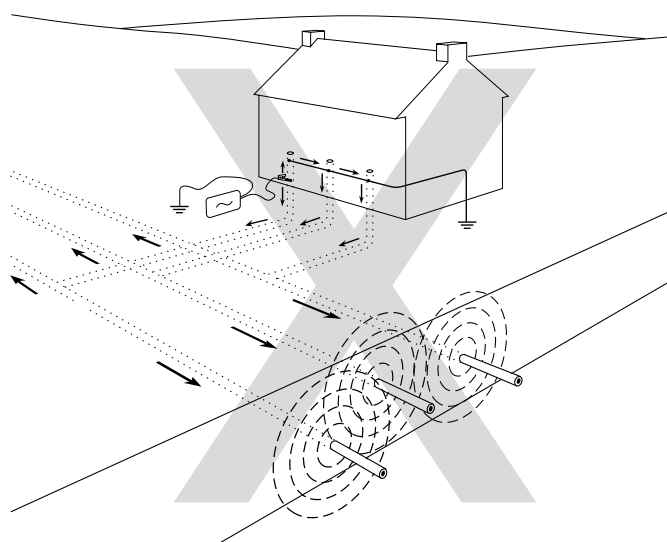
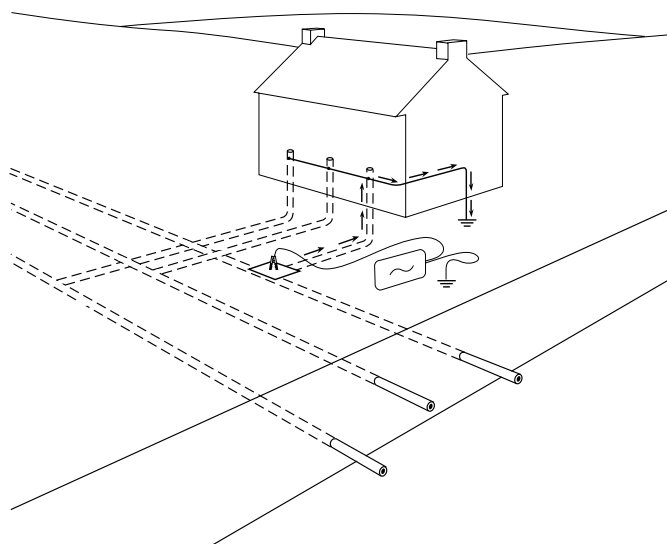
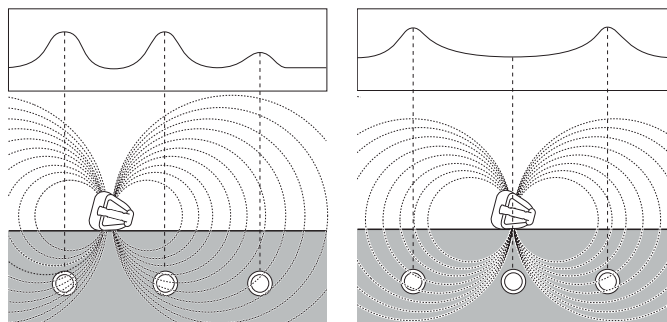

- Avoid applying the signal by induction. The signal may be coupling to more than one line directly from the transmitter. Use the signal clamp where possible.
- Identify points where lines may be bonded or in close proximity to each other. Work toward these points rather than away from them. For example, if gas and water pipes are bonded within a building, apply the signal at the valves or access points in the road rather than in the building.
- Reduce coupling to a parallel line by using a low signal frequency where available.
- Return signal flowing on another line. Use a double-ended connection to by-pass the ground return if possible.
- Choose a signal application point where the line is furthest from other lines and not in a congested area.
- When using single-ended connection, site the ground stake as far from the target line as possible and away from other buried lines.
- Avoid using existing structures for ground connections; other buried lines may be bonded to them.

A bad ground connection or just laying the ground lead on the surface at right angles to the line may result in less coupling than a good ground provided long distance tracing is not required.

6.2 Signal grounding

6.2.1 Manhole covers

Sometimes when locating, it is not possible to insert the ground stake into the earth, for example, when locating on hard ground such as roads. In this case, the ground return can be made by attaching the ground lead to the metal frame of a manhole.

6.2.2 Using lighting columns

Direct connecting to a metal, street-lamp column is almost as effective as connecting to the cable sheath itself. Normally the cable sheath is bonded to the metal column, therefore a simple connection onto the column enables the user to locate the street lighting quickly and safely without having to call out a technician from the lighting company.

If the lighting column is made from concrete make the transmitter connection to the cable sheath unless the cable is earthed to the inspection doorframe. Connection to the cable sheath applies the transmitter signal for a considerable distance enabling the locator to trace cables feeding illuminated street furniture as well as other street lights.

⚠ WARNING! The live cable connector is for use only by operators licensed or permitted to work on live cables.

When the cable is not grounded at the column, open the inspection door and connect the live cable connector to the live or neutral conductor.

The use of a street light column as a means of applying a signal to other power cables on the same electric circuit is a possibility. The signal may be weak using this method because it may have travelled some distance back to the sub-station and out again on the other system. With the locator used on a high sensitivity setting it is often possible to locate a cable, which would otherwise have been difficult or inconvenient to energize with the transmitter signal.

6.2.3 Finding a good ground point

When using a direct connection, it is important to get the best possible grounding for the transmitter. This provides the lowest resistance ground path and the best output signal. If it is not possible to use the ground stake the following are examples of good alternative ground points:

- Metal manhole covers.
- Metal drainage grates.
- Metal railings.
- Metal fence posts.

6.3 Double-ended connections

Large diameter water pipes and gas distribution pipes that are laid in sections sometimes have insulated joints between the sections and can be difficult to locate using a single ended connect. This is because when using a single ended connection ground return, signals can often cause confusion by returning to the transmitter along other lines. The problem sometimes occurs when return signals appear stronger than on the target line, usually because the target line is deeper than the line carrying the return signal, or the return path may be a better electrical conductor than the target line.

Applying a double-ended transmitter connection is a useful technique for positively tracing and identifying a target line in a situation such as a heavily congested industrial site, provided there are access points at each end of the line.

6.3.1 Making a double-ended connection

Connect the transmitter to an access point on the target line. The transmitter ground is connected with a long cable to another access point further along the line. A complete circuit is achieved without using ground as a current return path. The long cable should be kept as far away as possible from the expected route of the line. Radiodetection supplies 50 meter and 200 meter extension cables for this purpose.

This method of applying the transmitter signal is ideal for positive identification of a target line. When a connection has been made to two points on the same line, the same level of current should be detectable all round the circuit. The locator display should remain constant if the depth of the line does not change.

Figure 6.5: Making double-ended connections

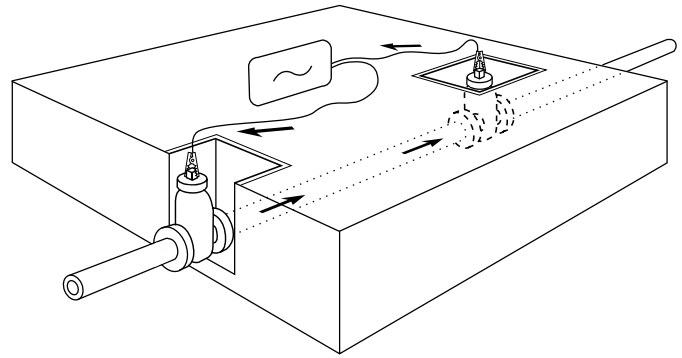

Section 7 – Using Accessories

7.1 About accessories

Both the transmitter and locator are compatible with a wide range of accessories, including the relevant RD7000/RD8000/RD4000 accessories. Use clamps to help apply a signal to pipeline or live wire. Use an A-Frame to provide the RD7000+ locator with advanced fault-finding capabilities.

When an accessory is connected, the locator or transmitter will instantly recognize it and will enable the mode appropriate to the accessory. For example, attaching an A-Frame to the RD7000+ locator will automatically switch the locator to fault-find mode and limit the number of available frequencies to those that are compatible with the A-Frame. The LCD will also display an icon of the accessory and will remove non-essential icons from the screen.

For a full list of supported accessories, please refer to Appendix 10.3.

7.2 Locator clamps

A locator clamp is used to positively locate and identify a cable when several cables are running close together.

A target cable can be identified in a chamber, on a tray or other access point by fitting a clamp to the locator and examining each cable in turn. Signal strength response shown on the locator display should be noted for each cable.

7.2.1 When to use clamps

Clamps can be used where:

- Several cables or pipes run in close proximity to each other.
- A cable or pipe is accessible at an inspection hole or manhole.

7.2.2 Connecting a clamp

1. Put the clamp connector into the accessory socket on the front of the RD7000+ locator.
2. Place the clamp around the pipe or cable and switch the locator on.
3. Set the frequency to the same as that on the transmitter.
4. Put the clamp around each cable in turn and note the bar graph response. Compare the strength of response from each cable. The cable with a substantially stronger response than the others will be the cable to which the transmitter signal has been applied.

Figure 7.1: Connecting a locator clamp

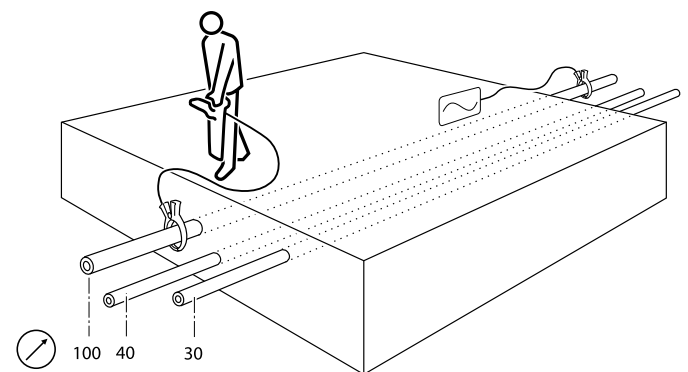

To ensure that the target cable has been correctly identified, reverse the positions of the transmitter and locator and check that the strongest response is still received from the target cable by the locator in its new position.

7.2.3 Available locator clamps

Standard clamp

The clamp plugs into the locator accessory socket and is used for cable identification at points where the cable can be accessed. The standard clamp is suitable for cables up to 100mm (4 inches) diameter.

Figure 7.2: Standard clamp

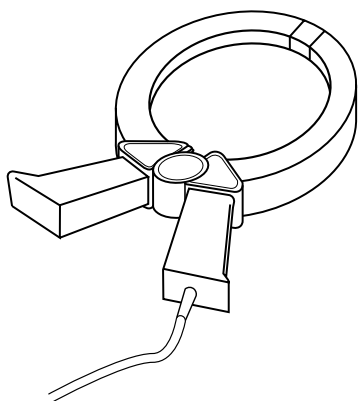

Small clamp

The small clamp performs the same function as the standard clamp but is useful in cramped situations where there is insufficient access for the standard clamp.

The small clamp is suitable for cables up to 50mm diameter.

7.3 Transmitter clamps

The transmitter clamp fits around a pipe or cable and safely applies a signal to a live cable without interrupting or disconnecting the supply. The clamp applies a very discriminating signal to a target line with reduced coupling to other lines. A clamp can sometimes be a more effective method of applying the signal than direct connection.

The target line will carry the strongest signal. The other lines will carry the weaker return signal. If the system comprises only two conductors, they may carry equal signals.

⚠ WARNING! When clamping around a power cable ensure that the clamp is connected to the transmitter at all times.

The clamp may buzz or vibrate if it is placed around a power cable that has significant net current flow. This is normal and does not harm the equipment.

7.3.1 Connecting the clamp

Plug the clamp into the transmitter output socket.

Put the clamp around the pipe or cable and ensure that the jaws are closed. Switch the transmitter on.

The line should be grounded (earthed) on each side of the clamp for the signal to transfer to the line. Ground the line if necessary. An insulated cable may be traced even if it has no actual ground connection, providing a reasonable length is buried either side of the clamp to provide capacitive coupling to ground (earth).

Figures 7.3 – 7.4: Connecting transmitter clamps

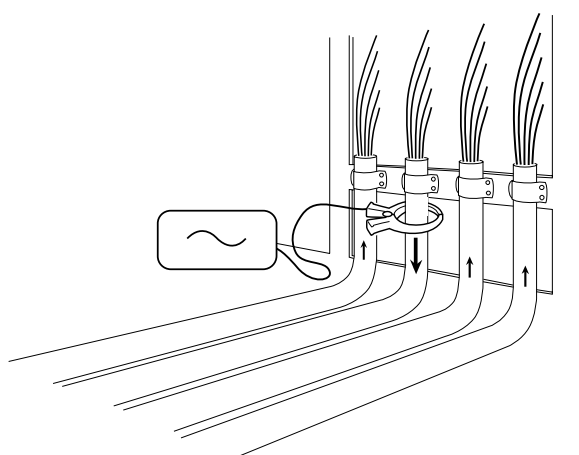
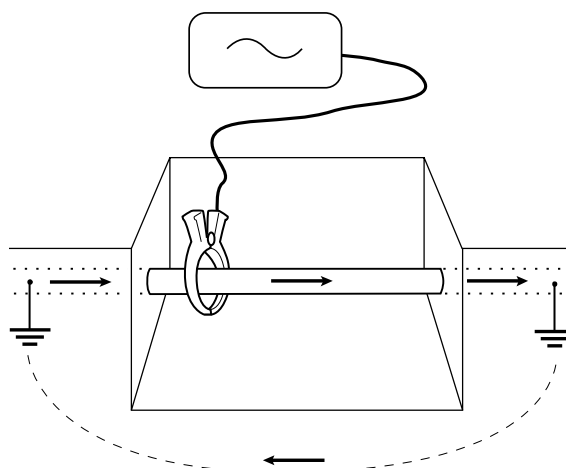

NOTE: It is not necessary to make a ground connection from the transmitter when using the clamp.

7.3.2 Available transmitter clamps

Although transmitter and locator clamps look the same, they have different internal windings. To prevent the wrong clamp being connected, transmitters and locator clamps have plugs of a different orientation.

Standard signal clamp

The standard clamp applies the transmitter signal very selectively and effectively to a target cable up to 100mm (4") diameter at frequencies from 8kHz to 200kHz.

The standard and small clamps have a double spring action for positive toroidal contact.

Small signal clamp

The small signal clamp is useful for applying a signal to a target cable in a pedestal or other place with limited space. The clamp is suitable for cables up to 50mm (2") diameter and can also be used for frequencies from 8kHz to 200kHz.

⚠ WARNING! The transmitter must only be connected to live services using the appropriate accessory such as a plug connector or live cable connector.

7.4 Sondes

7.4.1 When to use a sonde

A sonde transmitter is a small battery powered signal transmitter that can be inserted into non-metallic ducts, drains or sewers so they can be located and traced with a locator. A wide range of transmitting sondes is available to suit different applications. Sondes can also be used to pinpoint joints in iron gas pipes, locate blockages in plastic water pipes and monitor the progress of horizontal boring tools.

7.4.2 Choosing a suitable sonde

Check that the sonde has sufficient range for the application and is dimensionally small enough and sufficiently robust for the application. Ensure that the frequency of the sonde corresponds with the locator frequency; the locator will not locate the sonde unless the frequencies are the same. Sondes are marked with their transmitting frequency. Ensure that the means of propelling the sonde is available together with the correct fittings and couplings.

7.4.3 Preparation

Insert a new battery into the sonde. A new battery or a freshly recharged battery should be used at the beginning of each day and preferably at the start of each new job.

Before inserting the sonde, check that the sonde and locator are at the same frequency and working correctly. To do this, place the sonde on the ground at a distance from the locator that is equal to the rated depth of the sonde. Point the locator at the sonde with the antenna in line with the sonde (the opposite of using the locator to locate a line) and check that the bar graph reading exceeds 50% at maximum sensitivity.

7.4.4 Propelling a sonde

Sondes have a male thread at one end for connecting to drain rods, or to other devices for inserting and propelling the sonde along a drain or duct. Sondes may be floated along drains at the end of a tether and floats are available for fitting to the sewer sonde and super sonde. Sondes can be strapped to high-pressure water jets or similar devices used for cleaning, maintaining and inspecting drains. Sondes used in underground drilling and boring operations are normally housed in the boring or drill head behind the boring or drill bit.

7.4.5 Locating and tracing a sonde

Insert the sonde in the drain or duct access and locate it while it is still just in view at the drain or duct entrance. Hold the locator vertical directly over the sonde with the antenna in line with the sonde. Adjust the locator sensitivity so the bar graph reads between 60% and 80%.

The sonde radiates a peak field from the center of its axis with a ghost signal at each end of the peak. Move the locator a little way behind and then in front of the axis of the sonde to detect the ghost signals. Finding the two ghost signals positively confirms the locate. Reduce the locator sensitivity to lose the ghost signals but still indicate a clear peak response directly over the sonde. Locator sensitivity is now set for tracing the duct or drain unless the distance between sonde and locator changes.

Propel the sonde three paces along the drain or duct and stop. Place the locator over the supposed position of the sonde. Do not adjust the sensitivity level.

To locate a sonde:

1. Move the locator backwards and forwards and stop when the bar graph indicates a peak. You can use the LCD compass to orient the blade of the locator with the direction of the sonde.
2. Rotate the locator as if the blade is a pivot. Stop when the bar graph indicates a peak.
3. Move the locator from side to side until the bar graph indicates a peak.
4. Repeat 1, 2 and 3 with the antenna vertical and resting on or just above the ground. The locator should then be directly above the sonde with the antenna inline with it. Mark the position of the sonde and its direction.
5. Propel the sonde a further 1 or 2 meters, pinpoint, and mark the position. Repeat this pinpoint procedure at similar intervals along the line of the drain or duct until the survey is completed.

Figure 7.6: Sonde deployment

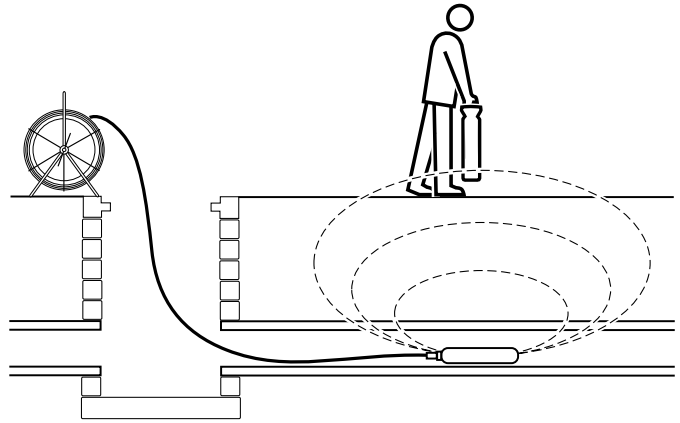

Figure 7.7: Locating a sonde

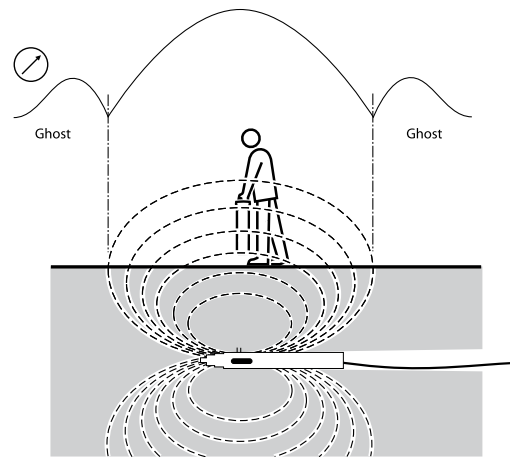
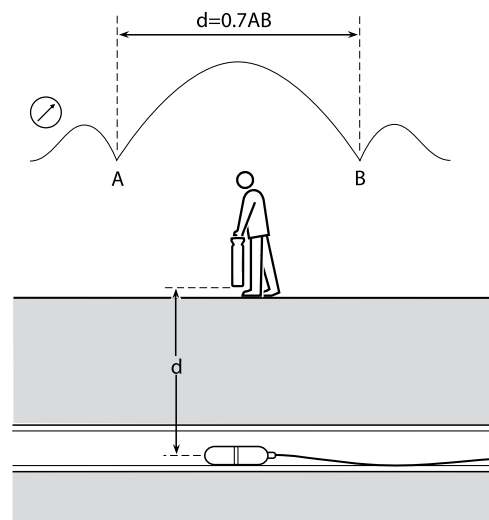

Figure 7.8: Calculating sonde depth



7.4.6 Checking sonde depth

The RD7000+ locator will automatically display the depth of a located sonde providing the locator is correctly oriented and positioned above the sonde. Using the LCD compass as a guide, rotate the locator until the compass indicates the sonde is in East/West position.

Calculation method

Pinpoint the sonde. Move the locator in front of the sonde and still with the antenna in line with it, increase sensitivity to find the peak of the ghost signal. Move the locator to behind the sonde ensuring that the locator blade is always in line with the sonde. Find the null positions A and B (see Figure 7.8). Measure the distance between them and multiply by 0.7 to give an approximate depth measurement.

7.4.7 Types and range of sondes

Standard sonde

The standard sonde combines compact size with a strong signal and is the standard sonde for most applications unless a smaller size, greater depth or rugged construction sonde is required.

Figure 7.9: Standard sonde

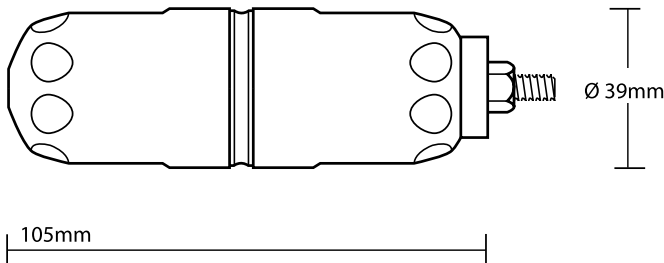

Super small sonde

This is a specialized sonde particularly suitable for no-dig applications. This type of sonde has an interchangeable battery compartment so that the length of the sonde can be altered. Shortening the length of the sonde means that fewer batteries can be accommodated and this will affect battery life.

Figure 7.10: Super small sondes

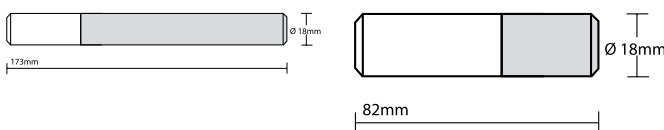

Sewer sonde

This sonde incorporates a very strong housing and makes the sonde suitable for use in municipal sewer systems. The sonde has a long life for daily use in all conditions.

Figure 7.11: Sewer sonde

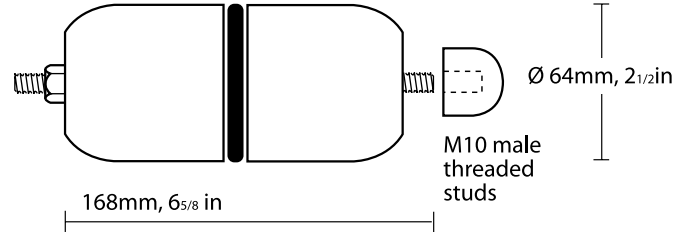

Super sonde

A particularly rugged sonde for use in deep sewers.

FlexiTrace

The FlexiTrace is a traceable plastic covered fiberglass rod incorporating wire conductors and is used for locating small diameter, non-metallic pipes to a depth of to 3 meters. The FlexiTrace can be inserted into a pipe or duct as small as 12mm/0.5 inch internal diameter with a minimum bend radius of 250mm. Batteries are not required, as the FlexiTrace is powered by the RD7000+ transmitter.

The FlexiTrace can be used in two modes: Sonde mode or Line mode. In sonde mode only the tip of the FlexiTrace is energized whilst in line mode its whole length is energized.

To use as a sonde, connect both transmitter leads to the FlexiTrace stud terminals. As the FlexiTrace terminals are not color coded it does not matter to which terminals the leads are connected. To use the FlexiTrace in line mode, connect the red transmitter lead to a FlexiTrace terminal and ground the black lead.

Figure 7.12: FlexiTrace

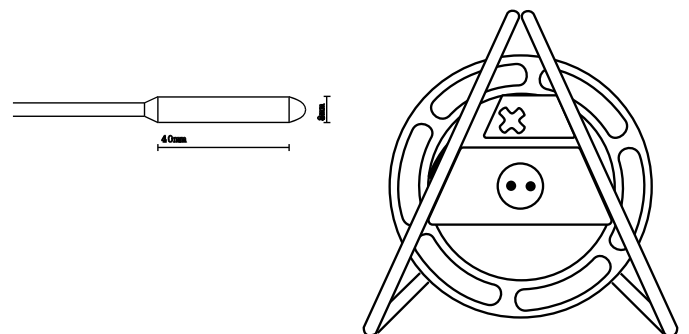

7.5 Stethoscopes

7.5.1 When to use a stethoscope

At times, it may not be possible to put a locator clamp around a cable because of congestion or because of inaccessibility. A stethoscope antenna should be used in the place of the clamp to identify cables.

7.5.2 How to use a stethoscope

Plug the stethoscope into the locator accessory socket. Press the concave head against each cable in turn to detect a maximum signal.

7.5.3 Types of stethoscope

Large stethoscope antenna

The large stethoscope antenna, which plugs into the locator accessory socket, is used for cable identification in situations where the cable is exposed. It is particularly useful for identifying heavy cables lying in a tray where it is not possible to fit a clamp. The concave detector head on the end of the insulated, flexible gooseneck is placed firmly against the cable to be identified. If there are a number of cables, the stethoscope antenna will give the strongest response from the cable to which the transmitter signal has been applied.

Small stethoscope antenna

The small stethoscope antenna has a 25mm concave head at the end of a 2m lead. The small stethoscope can be screwed into an extension rod or used at the end of several extension rods joined together for identifying inaccessible small cables.

Miniature hi-gain stethoscope

The miniature stethoscope is similar to the small stethoscope but has no handle or facility for extension rods.

The miniature stethoscope can also be used as a miniature antenna for locations where the bulk of the locator makes it inconvenient for use, such as locating pipes or cables in walls.

7.6 Submersible antenna

7.6.1 When to use a submersible antenna

Tracing buried pipes and cables across waterways and estuaries are frequent and critical locating applications. Less frequent but equally important is tracing and locating lines between the mainland and offshore islands. When locating pipes and cables the locator sensing antennae should be as close as possible to the target line so it is not practical to locate lines buried under a river or seabed from the surface. In most cases, it is necessary to measure the depth of cover to ensure the line is protected from dragging anchors or other underwater hazards.

The submersible, double depth antenna is suitable for use under water for tracing pipes or cables. There is a weight at the bottom of the antenna for stability and the unit has been pressure tested to IP68 to a depth of 100m.

The antenna is supplied with 10m of submersible marine umbilical cable as standard, but lengths of up to 100m can be supplied. The extra length enables the antenna to be carried by a diver on a riverbed or seabed while the locator is used in a surface vessel. It is crucial to have effective communication between the operator with the locator and the diver with the antenna.

Alternatively the antenna can be fastened to the end of a non-metallic boom from a barge and lowered to the riverbed or seabed.

7.6.2 How to use a submersible antenna

Apply the transmitter signal to the target line at an access point on the shore. The submersible antenna line for tracing the line underwater is plugged into the accessory socket of the locator. The locator is used onboard a boat, which should be positioned directly over the line. The transmitting signal should be by direct connection with the strongest possible signal and a low frequency (less than 1kHz). Make a ground connection about 50m from the transmitter. Test the quality of signal on the line before locating on the water.

NOTE: The submersible antenna is calibrated to work at a single frequency, which is specified at purchase.

Tips for using a submersible antenna

The user in the boat should be a specialist or have considerable experience using a locator so that they can give concise instructions to the diver.

It is prudent for the pair to practice working together on dry land before attempting to locate underwater. Using the antenna the diver should locate and trace a known line blindfolded receiving directions from the user with the locator out of sight of the line and the diver.

Because of rapid signal loss and a combination of large surface area and very conductive soil there may be problems applying a suitable signal for tracing a large diameter pipe. It may be necessary to use a high power, low frequency tracing signal.

It is necessary to define a method of recording target line position and depth before starting work in the boat or on the seabed.

Figure 7.13: Using a submersible antenna

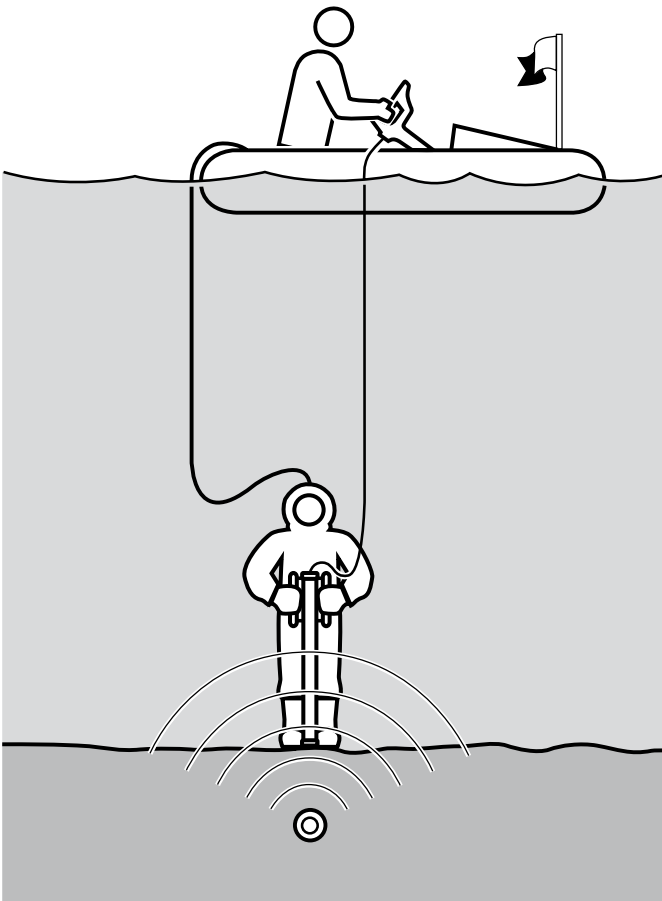

Section 8 – Fault-Finding

8.1 About fault-finding

The RD7000TL+ and RD7000PL+ models are capable of locating cable to ground faults caused by damaged cable sheaths. This process is known as “8K Fault-Finding” as it uses an 8kHz signal applied to a target line with a transmitter.

The accessory A-frame is used to locate cable sheath faults on power and telecom cables. To use Fault-Find you will need the following equipment:

- RD7000TL+ or RD7000PL+ locator
- Tx-3 or Tx-10 transmitter
- Accessory A-frame connection leads.

8.2 Preparation

Using RD7000+ standard locating techniques locate the cable for a short distance and trace and mark its route. Remove all earth bonds from the line to be traced during the fault-finding survey.

8.2.1 Connecting the transmitter

1. Switch the transmitter off.
2. Push the connector plug into the transmitter accessory socket.
3. Clip the red connection lead to the cable or cable sheath ensuring that the area around the connection is clean.
4. Extend the black connection lead as far away as possible and at 90° to the probable route of the target cable and clip the connector to the ground stake.

NOTE: Always connect the black connection lead to a ground stake and not a water pipe or buried cable, as these may carry the signal.

8.2.2 Reference readings





It is good practice to obtain a reference reading from the ground stake before you attempt to locate a fault on a target line. Reference readings help to provide the following information:

- Severity of fault.
- Survey interval.

Before taking the reference reading set up the transmitter and locator as follows:

On the transmitter:





1. Switch the transmitter on by pressing the  key.
2. Select a fault-finding frequency using the  key.
3. Use the  or  arrows to increase or decrease the 8kHz power output level.
4. If required you can use the BOOST setting if the fault is located on a high resistance cable or if the cable is long.

WARNING! By selecting 8kHz output a high voltage warning icon will appear on the transmitter's LCD.

Move to the next step of the procedure.

On the locator:



1. Switch the locator on by pressing the  key.
2. Connect one end of the connection lead to the A-frame socket.
3. Connect the other end to the locator accessory socket.
4. The locator will automatically recognize the A-frame and display the A-frame icon on the LCD.
5. Select a fault-finding frequency using the  key.

NOTE: If the locator and transmitter are iLOC enabled then you can remotely control the transmitter using the locator. See Section 6 for more information.

Obtaining a reference reading:

Position the locator approximately 2m (6 feet) from the ground stake and push the A-frame spikes into the ground with the green spike towards the ground stake

Attach the locator to the A-frame by the retention hook. (If you are holding the locator separately, make sure that the locator is in line with the A-frame and is pointing towards the green spike.) The fault direction arrow should be pointing away from the ground stake. If it is not, make sure that the transmitter is connected correctly (red connector to the cable and black to the ground stake)

Take the dB reading and keep it for reference. If there is a single fault on the cable, it will be approximately the same dB value as the reference reading.

NOTE. To establish how often to take readings on the cable, move away from the ground stake and take further readings until the arrow has difficulty in locking and the dB reading is low. Measure the distance that the locator is now away from the ground stake. This is the distance that you can safely use between taking readings on the cable to ensure that you do not miss the fault.

8.3 How to find a fault

Starting from the transmitter, walk along the cable route pushing the A-Frame spikes into the ground with the green spike pointing away from the transmitter. Where there are no faults the dB reading will be low and the direction arrow may flicker forward and back.

NOTE: Flickering arrows may also indicate that you may be too far away from the fault or ground stake (or both) for the locator to lock on.

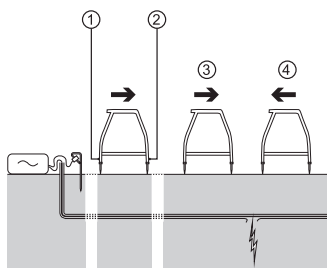

If you are trying to locate high resistance faults or there is a long distance between faults, carry on with the survey and the locator will lock on when you get closer to the fault.

Figure 8.1: Cable sheath fault-finding

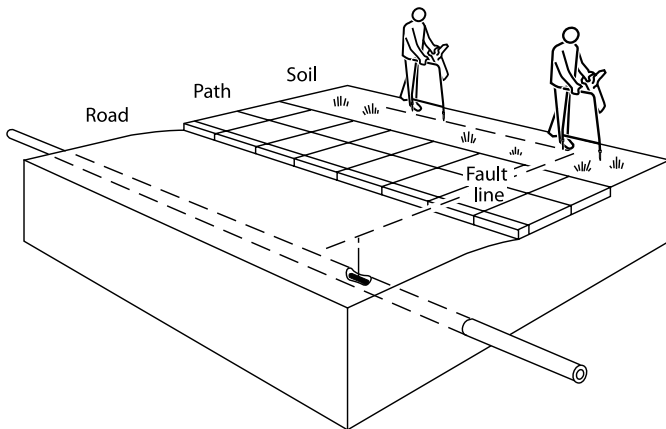



Figure 8.2: Locating cable sheath faults with the locator and A-Frame

Take readings at the survey intervals determined by the reference reading. To locate the cable during a Fault-Find survey, press the  key once and the locator will switch to 8kHz null mode. Locate the cable using the normal null mode technique. Press the  key again to return to Fault-Find mode.

As a fault is approached the Fault-Find direction arrow will lock on to the fault signal and point forward and the dB readings will increase. When the fault is passed the arrow will point back towards the transmitter. Take readings at smaller survey intervals to determine the exact point of the fault.

When the A-frame is directly over the fault the dB reading will drop as shown opposite.

NOTE: The values given are for illustration purposes only and may not be the same as those obtained in other situations.

To pinpoint the fault, turn the A-frame 90° to the cable and Fault-Find until the exact point is found where the arrow direction changes. The center line of the A-frame is now directly over the fault.

Mark the ground to show the position of the fault. Find the maximum dB reading in front of the fault by pushing the A-frame into the ground at small intervals. Note the dB reading. If the reading is approximately the same as the reference reading, you can assume that there is only one fault. If the reading is less than the reference reading, keep surveying the cable for other faults.

Replace the bonds between the sheath and ground at each end of the line once the fault-finding survey has been completed.

NOTE: If the cable runs under a road, use the equipment as normal on the road surface as it can sometimes detect signals when working on blacktop, concrete, or paved surfaces. If necessary, try wetting the road surface. Pouring a very small amount of water around the bottom of the A-frame spikes before each Fault-Find will generally ensure a good ground connection.

NOTE: If the cable runs under a paved surface, the fault can often be pinpointed by fault finding in the grass/soil adjacent to the paving. Reduce the distance between placing the A-frame spikes in the ground to allow for the increased distance to the actual fault position.

Section 9 – Extended Warranty, eCAL™ and Maintenance

9.1 Product Registration and Extended Warranty

Your RD7000+ locator and transmitter are supplied with a 1 year warranty as standard. Radiodetection offers a free upgrade to a 3 year extended warranty on RD7000+ locators and the Tx range of transmitters through registration on www.radiodetection.com within 3 months of purchase. Registered products also receive free product software upgrades through Centros Manager as they are released; see sections 9.2 and 9.4 for details.

Please refer to Section 10.4 for the full warranty statement.

9.2 Centros™ Manager

Centros Manager is a Radiodetection PC application which is available as a free download from: www.radiodetection.com. From time to time Radiodetection will release new software for the RD7000+ locator and transmitter which may improve performance or stability and may include new features. The latest software is contained within Centros Manager and to download the latest software you must register your product (see section 9.1). Once registered you will be notified when new versions of software are available and you may also carry out an eCAL to validate the calibration and functionally test the RD7000+ locator.

9.2.1 Installing Centros Manager

NOTE: Before download you are advised to view or download the Centros Manager operation Manual by going to www.radiodetection.com/centrosmanager.

NOTE: When you install Centros Manager onto a PC, the following message may be displayed: “You need to log in as Administrator”. If this message is displayed, the installation of the program will not complete. You will need to log on as an Administrator or ask a user with Administration Rights to install the program on your behalf. Having successfully installed Centros Manager, the Administrator will need to carry out the instructions in Section 7.1 of the Centros Manager Operation Manual if they wish users without Administrator Rights to use Centros Manager.

1. Go to: www.radiodetection.com/centrosmanager.
2. Click on the link to download Centros Manager and a File Download Window will appear. You will have a choice of either, **Run** or **Save**.
Run: Centros Manager will automatically install.
Save: you will be given the option to save Centros Manager to a destination of your choice. Once you select the destination, the Centros Manager executable program will download to that destination. Once completed you will have the option to **Run** or **Open Folder**. At this stage Centros Manager has not been installed so you can either select Run and Centros Manager will automatically install, or you can choose to Open Folder. When you open the folder the Centros Manager executable file will be available. To install double click on this file.
3. When Centros Manager is installed run from the Windows Start menu under Programs or alternatively, use the Centros Manager shortcut on your desk top if you have opted to have this during installation of Centros Manager.

NOTE: Once Centros Manager is open, click on Help to open the Centros Manager Operation Manual.

9.3 eCAL™

Unique to Radiodetection precision locators, eCAL™ allows users to validate the original factory calibration of the RD7000+ locator through a PC. By checking the responses of all relevant internal components, eCAL™ provides the user with confidence that the locator performs as it did when it first left the factory, and allows the owner to print or save a validation certificate without the need to return the RD7000+ to a service center. eCAL™ is part of the Centros™ Manager software suite.

eCAL™ provides users with the following tools, which may be accessed and carried out on site:

- Check the validation of the RD7000+ against the original factory calibration results.
- Carry out a functional check.
- Retrieve the original factory calibration certificate or previous eCAL validation certificates.

To validate your RD7000+, you must first carry out the following:

- Register your RD7000+ locator at:
www.radiodetection.com/extendedwarranty.
See section 9.4 for more details.
- Purchase an eCAL™ key at:
www.radiodetection.com/ecal or alternatively contact your local Radiodetection representative.
- Download Centros Manager at:
www.radiodetection.com/centrosmanager.
See page 13 for details.

9.3.1 Using eCAL™ to validate the RD7000+

1. Connect the RD7000+ via the USB connector inside the battery compartment to a suitable USB port on a PC or laptop.
2. Switch on the RD7000+ (no segments will be lit but the backlight will be on).
3. Open Centros Manager and click on Locator eCAL Validation.
4. Copy the eCAL™ key (received in your confirmation email when purchasing the eCAL™ key), click on Load Validation Key icon and paste the eCAL™ key.
5. Click on Run eCAL™ Validation. A message box will automatically open informing you of progress.
6. In less than 3 minutes the eCAL™ Validation Status will be displayed. To view or print the certificate, locate the serial number of the RD7000+ within the Unit Manager window and expand the contents. Expand Calibration History and double click on the latest date to display the certificate of validation.

9.3.2 Using eCAL™ to retrieve the original factory calibration certificate

The original factory calibration results for the RD7000+ locator can be retrieved from the unit. Each time the RD7000+ is calibrated either at Radiodetection or an approved Radiodetection service centre, the calibration results are stored within the locator. To retrieve the results and print a certificate, carry out the following process:

NOTE: You do not need to purchase an eCAL™ validation key to retrieve the original factory calibration certificate.

1. Register your RD7000+ locator by going to:
www.radiodetection.com/extendedwarranty.
See section 9.1 for more details.
2. Download Centros Manager by going to:
www.radiodetection.com/centrosmanager.
See section 9.2 for details.
3. Connect the RD7000+ via the USB connector inside the battery compartment to a suitable USB port on a PC or laptop.
4. Switch on the RD7000+ (no segments will be lit but the backlight will be on).
5. Open Centros Manager and click on Locator eCAL™ Validation.
6. Click on Get Original Calibration Data and a message box will automatically pop up displaying the progress.
7. In less than 3 minutes the original calibration certificate will be available to view or print. Locate the serial number of the RD7000+ within the Unit Manager window and expand the contents. Expand Calibration History and click on each date.

When you click on each date, the type of certificate, whether an eCAL™ validation or original factory calibration, together with date and serial number will be displayed. By clicking on this window, the certificate will be displayed and you can choose to print this certificate.

9.4 Upgrading software

From time to time, Radiodetection will release software upgrades to enhance features and improve performance.

You can upgrade your RD7000+'s software by using Centros™ Manager and your desktop or notebook computer. Centros™ Manager is available from:
www.radiodetection.com.

NOTE: You must first register for an extended 3-year warranty before you can upgrade your RD7000+ locator. Registration is free.

For more information please visit **www.radiodetection.com**

9.5 Care and maintenance

The RD7000+ locator and transmitter is robust, durable and weatherproof. However you can extend your equipment's life by following these care and maintenance guidelines.

9.5.1 General

Store the equipment in a clean and dry environment.

Regularly validate your equipment using eCAL. Validation ensures the equipment is valid according to its original factory calibration. (See Section 9.2)

Ensure all terminals and connection sockets are clean, free of debris and corrosion and are undamaged.

Do not use this equipment when damaged or faulty.

9.5.2 Batteries and power supply

Use only good quality Alkaline or NiMH batteries D-Cell (LR20) batteries or the Radiodetection rechargeable battery packs suitable for your equipment.

When using an AC or vehicle power adapter, use only Radiodetection approved adapters.

9.5.3 Cleaning

 WARNING! Do not attempt to clean this equipment when it is powered or connected to any power source, including batteries, adapters and live cables.

Ensure the equipment is clean and dry whenever possible.

Clean this equipment with soft, moistened cloth.

If using this equipment in foul water systems or other areas where biological hazards may be present, use an appropriate disinfectant.

Do not use abrasive materials or chemicals as they may damage the casing, including the reflective labels.

Do not use high pressure hoses.

9.5.4 Disassembly

Do not attempt to disassemble this equipment under any circumstances. The locator and transmitter contain no user serviceable parts.

Disassembly may damage the equipment and or reduce its performance and may void the manufacturer's warranty.

9.5.5 Service and maintenance

Radiodetection recommends that you service your RD7000+ locator and transmitter regularly. Service your equipment at Radiodetection headquarters or Radiodetection authorized service centers.

NOTE: Service by non-approved service centers or operators may void the manufacturer's warranty.

Section 10 – Appendices

10.1 Specifications for the locator and transmitter

Sensitivity	6E-15Tesla, 5µA at 1 meter (33kHz)
Dynamic range	140dB rms /√Hz
Selectivity	120dB/Hz
Depth accuracy	Line: ± 5% tolerance 0.1m (4") to 3m (10ft) Sonde: ±5% tolerance 0.1m (4") to 7m (23ft)
Maximum Depth*	Line 6m (20ft), Sonde 15m (50ft)
Fault-Finding (FF)	Diagnose cable sheath faults from Short Circuit to 2MΩ using the A-frame
Batteries	Locator: 2 x D-cells (LR20) or rechargeable battery pack† Transmitter: 8 x D-cells (LR20) or rechargeable battery pack†
Warranty	36 Months upon registration
Dynamic overload protection	30dB (automatic)
Compliance	CE, FCC, RSS 310 RoHS, WEEE
Weight	Transmitter: 2.84kg (6lbs) (including alkaline batteries) 4.2kg (9lbs) (including supplied accessories) Locator: 1.87kg (4lbs) (including alkaline batteries)
Environmental protection	IP54
Operating temperature range:	-20°C to +50°C (4°F to 122°F)

*RD7000+ will locate to greater depths but accuracy may be reduced. †Available separately.

10.2 Supported frequencies

	SL	DL	PL	TL
Power	•	•	•	•
Radio	•	•	•	•
CPS 100/120Hz		•		
Active LF (512/640Hz)		•	•	•
Active 8kHz	•	•	•	•
Active 9.8kHz				
Active 33kHz	•	•	•	•
Active 65kHz	•	•	•	•
Active 83kHz	•			
Active 131kHz				•
Active 200kHz				•
Sonde 512Hz/640Hz		•		•
Sonde 8kHz		•		
Sonde 33kHz		•	•	•
Fault Find 8kHz (8kFF)			•	•

10.3 Supported accessories

Description	Part Number
Transmitter Accessories	
UK Plug Connector	10/AC1231-4KTX-LPC-UK
Euro Plug Connector	10/AC1231-4KTX-LPC-EUR
Live Cable Connector	10/AC1231-4KTX-LCC
2" (50mm) Transmitter Clamp	10/TC2136-4KTX
4" (100mm) Transmitter Clamp	10/TC1769-4KTX
Earth Reel	09/310-4KTX
Mains power AC transformer to 12V DC New	10/RD7K8KUMPSU
Tx Direct Connection Lead	17/TX2609E1
Earth Stake	04/PT1505N27
New Short Earth Stake	04/ET2980P8
8.5" (215mm) Transmitter Clamp	10/RD4GT0235
Signal Clamp Extension Rod	10/EXT
121 Transformer	10/RD2717-4KTX-ENG
12V Car Power Lead (with Isolation Transformer) New	10/RD7K8KDCI
Locator accessories	
High Gain Stethoscope	10/AC2645-4KRX
Small Stethoscope	10/AC2643-4KRX
Large Stethoscope	10/AC2644-4KRX
640/512Hz Submersible DD Antenna (10m Cable)	10/SM1099-640-4KRX
8kHz Submersible DD Antenna (10m Cable)	10/SM1099-8-4KRX
Additional Submersible Cable Length (Per Meter)	10/RD0246SUBCABL
Headphones	04/LP01
A-frame	10/AFRAME
A-frame Bag	10/RD4FFRXBAG
50mm (2") Locator Clamp	10/TC2136-4KRX
100mm (4") Locator Clamp	10/TC1769-4KRX
Soft Carry Bag	10/RD7K8KBAG
Soft Carry Bag with Wheels New	10/RD7K8KRBAG
Hard Case	10/RD7K8KCASE

Description	Part Number
Sondes and accessories	
Standard Sonde 33kHz Depth 5m	10/SC0412-33R
Sewer Sonde 33kHz Depth 8m	10/SA0337-33R
Super Sonde 33kHz Depth 15m	10/SB0338-33R
Slim Sonde 33kHz Depth 3.5m	10/SD0322-33R
Slim Sonde Plain End Cap	10/SD0223
Slim Sonde Blank End Cap	10/SD0268
S18A Sonde 33kHz	10/S18/82-33-000
S18B Sonde 33kHz	10/S18/173-33-000
8kHz Sonde	10/SCO412-8
512Hz Sonde	10/SCO412-512
Spring Coupling M10 Male	10/SU0335
Flexrod Coupler (Joins two Flexrods together)	02/FR0818N1
Flexrod Blank for Machinery	02/FR0336
115mm (4.5") Diameter Floats/Pair	10/SU0344
M10 Thread Protecting Nipple	02/P105O
External Shell for heavy-duty applications (Diameter as Sewer Sonde)	10/SC0963
Plastic or Cane Rod Connector, Male	02/SU0339
GD Rod Connector. 3/4" (19mm) x 12 BSF, Female	02/SU0340
Wards Rod Connector, 3/4" (19mm) x 10 BSW, Female	02/SU0341
Wards Rod Connector, 1/2" (13mm) x 12 BSW, Female	02/SU0342
Lockfast Connector, 3/4" (19mm) x 10 BSW	02/SU0676
Spring Coupling M10 Male	10/SU0335
FlexiTrace 50m	10/TRACE50
9mm 120m Flexrod	10/FLEXRODF120
9mm 60m Flexrod	10/FLEXRODF60
Batteries and rechargeables	
D-Cell Alkaline Battery for RD8000, RD7000+, RD7000, Tx-1, Tx-3, Tx-10 (LR20, MN1300)	04/MN1300
Transmitter Li-Ion rechargeable battery pack	10/TXRBATPACK
Locator rechargeable battery pack and charger (100-240V) (UK cordset)	10/RX-RECHARGEKIT-UK
Locator rechargeable battery pack and charger (100-240V) (US cordset)	10/RX-RECHARGEKIT-US
Locator rechargeable battery pack and charger (100-240V) (EU cordset)	10/RX-RECHARGEKIT-EU
Transmitter Li-Ion rechargeable battery pack (Incl mains, 12V chargers and lead) (US Cordset)	10/TXRBATPACKKIT-US
Transmitter Li-Ion rechargeable battery pack (Incl mains, 12V chargers and lead)(UK Cordset)	10/TXRBATPACKKIT-UK
Transmitter Li-Ion rechargeable battery pack (Incl mains, 12V chargers and lead) (EU Cordset)	10/TXRBATPACKKIT-EU
Transmitter Li-Ion rechargeable battery pack (Incl mains charger and lead) (US Cordset)	10/TXRBATPACK-MC-US
Transmitter Li-Ion rechargeable battery pack (Incl mains charger and lead) (UK Cordset)	10/TXRBATPACK-MC-UK
Transmitter Li-Ion rechargeable battery pack (Incl mains charger and lead) (EU Cordset)	10/TXRBATPACK-MC-EU
Transmitter Li-ion rechargeable battery pack automotive charger	26/ET3023U3
eCAL calibration key (or go to www.radiodetection.com/ecal)	10/RD7K8KECAL

EDENBROS, LLC

Products:

1. Pipe & Cable Locators
2. Metal Detectors
3. Sewer Cameras
4. Duct Rodders & Sondes
5. Leak Noise Correlators
6. Leak Listeners
7. Noise Loggers
8. Gas Detectors
9. Ground Penetrating Radar
10. Data Loggers
11. Tools
12. Software

Services:

1. CCTV Inspection
2. Leak Detection
3. Utility Location
4. Fault Finding
5. Ground Penetrating Radar
6. Thermal Imaging

Used Equipment & Ex-Demo
Items always available.

Check our website for a current
listing:

www.edenbros.com

EDENBROS, LLC
PO BOX 247
SAINT JAMES, MO 65559

Tel: 800-526-5246
Fax: 800-807-9368
Web: www.edenbros.com

