



EDENBROS, LLC

SEWERIN
Technologies for leak detection.

UT 9000



28.02.2014 a – 107297 – en

Operating instructions

UT 9000 R receiver

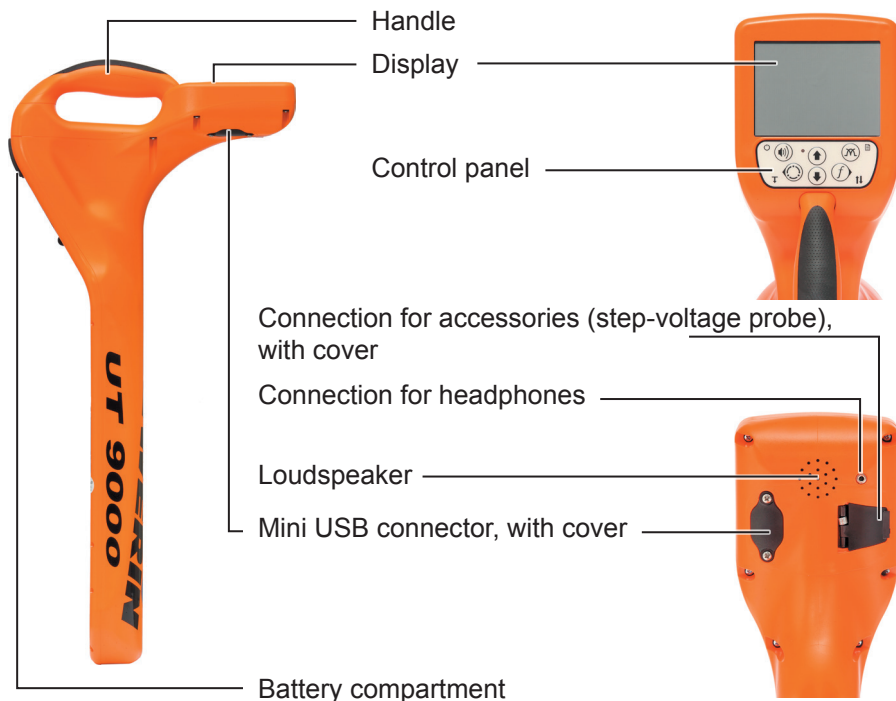

Fig. 1: UT 9000 R receiver

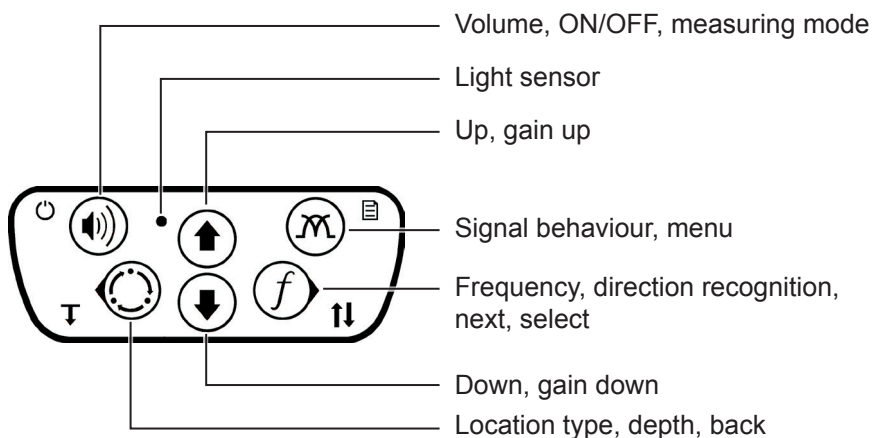

Fig. 2: UT 9000 R receiver control panel (functions of the keys)

UT 9012 TX generator

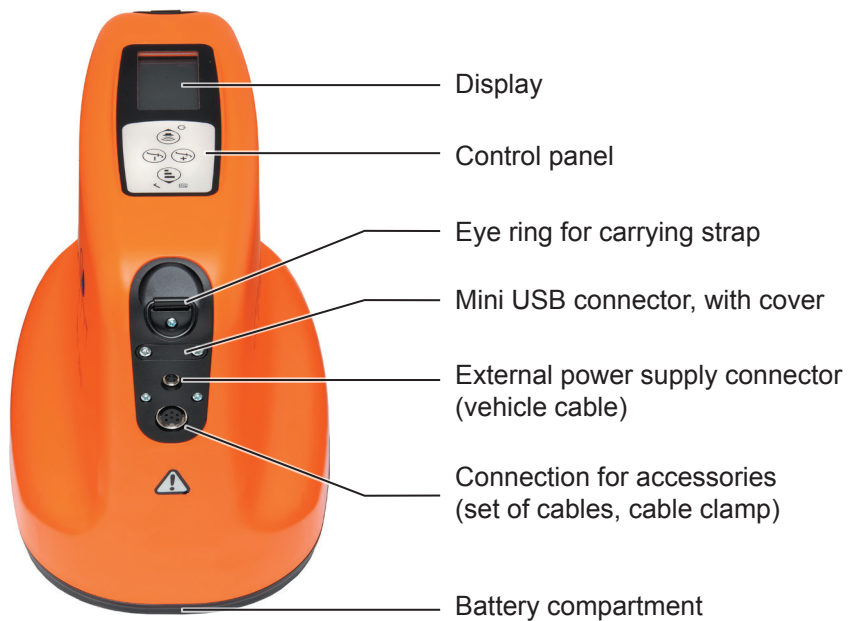

Fig. 3: UT 9012 TX generator

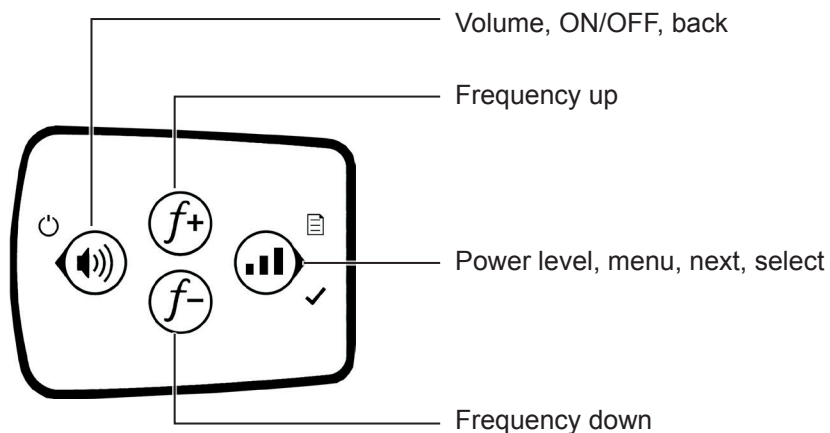

Fig. 4: Generator control panel (functions of the keys)

Information about this document

The warnings and notes in the document mean the following:



WARNING!

Risk of personal injury. Can result in serious injury or death.



CAUTION!

Risk of personal injury. Can result in injury or a risk to health.

NOTICE!

Risk of damage to property.

Note:

Tips and important information.

Enumerated lists (numbers, letters) are used for:

- Instructions that must be followed in a specific sequence

Bullet lists (bullet points, dashes) are used for:

- Lists
- Instructions comprising only one action

1	Introduction	1
1.1	Warranty	1
1.2	Purpose	2
1.3	Intended use	3
1.4	General safety information	3
2	UT 9000 R receiver	4
2.1	General	4
2.2	Location methods, location types and signal behaviour.....	5
2.3	Control panel.....	7
2.4	Display	9
2.5	Configuring the device (menu).....	13
2.5.1	Frequencies menu item.....	14
2.5.2	Settings menu item	14
2.5.2.1	Language	15
2.5.2.2	Units	15
2.5.2.3	Backlight.....	15
2.5.2.4	Shutdown Timer	15
2.5.2.5	Communications	16
2.5.3	Options menu item	17
2.5.3.1	Audio Mode	17
2.5.3.2	Audio Style	18
2.5.3.3	Gain.....	18
2.5.3.4	Autodepth.....	18
2.5.3.5	Offset Depth	18
2.5.4	System Info menu item	19
2.5.5	Ambient Noise menu item	19
2.5.6	TX Control menu item	19
2.6	Power supply.....	20
3	UT 9005 TX / UT 9012 TX generator.....	22
3.1	General	22
3.2	Operating modes.....	22
3.3	Control panel.....	23
3.4	Display	24
3.5	Configuring the device (menu).....	27
3.5.1	Frequencies menu item.....	28
3.5.2	Settings menu item	28
3.5.2.1	Backlight.....	28

3.5.2.2	Output	28
3.5.2.3	Meter	30
3.5.2.4	Communications	30
3.5.3	Options menu item	31
3.5.3.1	Language	31
3.5.3.2	Defaults	32
3.5.3.3	Step-voltage probe	33
3.5.4	System info menu item	33
3.6	Power supply	34
3.6.1	Changing the batteries	35
3.6.2	Lithium-ion rechargeable battery	36
3.6.2.1	Safety information regarding the lithium-ion rechargeable battery	36
3.6.2.2	Storage of the rechargeable battery	36
3.6.2.3	Charging the battery	37
4	Using the UT 9000 system	39
4.1	Device pairing	39
4.1.1	Pairing the generator and the receiver	39
4.1.2	Disconnecting the generator and the receiver	40
4.2	Frequency selection	40
4.2.1	Enabling a frequency	42
4.2.2	Selecting the frequencies	42
4.3	Gain control on the receiver	43
4.4	Depth measurement	44
4.4.1	Determining the depth automatically	44
4.4.2	Determining the depth manually	45
4.4.3	Determining the offset depth	45
4.5	UT 9000 software	47
5	Active location: lines	49
5.1	Determining the ambient noise	49
5.2	Energising a line	51
5.2.1	Galvanic energising	51
5.2.1.1	Parallel connection	52
5.2.1.2	Points to note when changing the set of cables	54
5.2.2	Inductive energising	55
5.2.2.1	Energising with a cable clamp	55
5.3	Locating a line	56
5.4	Direction recognition	58

Contents	Page
5.5	High Power..... 60
6	Active location: sondes 62
7	Passive location 65
8	Troubleshooting 68
8.1	Sources of error when locating 68
8.2	Problems with the receiver 69
8.3	Problems with the generator 69
9	Appendix 71
9.1	Technical data 71
9.1.1	UT 9000 R receiver 71
9.1.2	UT 9005 TX / UT 9012 TX generator 72
9.2	Pre-set frequencies (factory settings) 74
9.2.1	UT 9000 R receiver 74
9.2.2	UT 9005 TX / UT 9012 TX generator 75
9.3	Accessories and consumables..... 76
9.4	EC Declaration of Conformity..... 76
9.5	Advice on disposal 77
10	Index 78

1 Introduction

1.1 Warranty

The following instructions must be complied with in order for any warranty to be applicable regarding functionality and safe operation of this equipment. The product must only be operated by qualified specialist technicians.

- Read these operating instructions prior to operating the product.
- Use the product only as intended.
- Repairs and maintenance must only be carried out by specialist technicians or other suitably trained personnel. Only spare parts approved by Hermann Sewerin GmbH may be used when performing repairs.
- Use only suitable battery types.
- Changes or modifications to this product may only be carried out with the approval of Hermann Sewerin GmbH.
- Use only Hermann Sewerin GmbH accessories for the product.

Hermann Sewerin GmbH shall not be liable for damages resulting from the non-observance of this information. The warranty conditions of the General Terms and Conditions ("AGB") of Hermann Sewerin GmbH are not affected by this information.

In addition to the warnings and other information in these Operating Instructions, always observe the generally applicable safety and accident prevention regulations.

The manufacturer reserves the right to make technical changes.

1.2 Purpose

UT 9000 is an electronic location system for detecting electrically conductive lines laid in the ground. The system comprises the **UT 9000 R** receiver and a generator (**UT 9012 TX** or **UT 9005 TX**). Data is sent between the receiver and the generator via bidirectional radio.

The **UT 9000** can be used for:

- Locating and tracking lines
Lines refers here to both power and signal cables as well as supply lines, for example.
- Determining the depth of a line

Location can be carried out passively or actively. For active location, the required electromagnetic field is generated by means of a generator. Passive location makes use of existing electromagnetic fields.

As with other systems, it is always advisable to check the plausibility of the result of the **UT 9000** location process.

Note:

In these operating instructions, we describe the **UT 9000** system working in conjunction with a **UT 9012 TX** generator. The descriptions are also valid for the **UT 9005 TX** generator, however it offers fewer functions.

All descriptions refer to the system as delivered (factory settings). The manufacturer reserves the right to make changes.

1.3 Intended use

UT 9000 is intended for professional industrial and commercial use. The appropriate specialist knowledge is required to operate the device.

Note:

If necessary, learn more about pipe location theory before commencing practical work with the **UT 9000**.

The system must only be used for the applications specified in Section 1.2.

1.4 General safety information

- Contact the local utility companies to establish the route of underground cables and lines before commencing location work.
- Before starting work, check that the equipment is in good working order. Never use damaged or faulty equipment.
- Never use the equipment in the vicinity of explosive areas.
- Always adequately secure the setup locations of the equipment to prevent injury to persons and damage to vehicles.
- Always observe the applicable safety regulations when working on electrical installations (e.g. power cables).
- Do not drop the devices.
- Never place the devices in places where they are at risk of falling.
- Ensure that no dirt or moisture can get into the connections on the devices.
- Always observe the permitted operating and storage temperatures.
- Do not immerse the devices in liquids.

2 UT 9000 R receiver

2.1 General

The **UT 9000 R** receiver receives the signals from electromagnetic fields. The signals are relayed:

- audibly via a loudspeaker or headphones
- visually on the display

The field strength is displayed in graphical and numerical form on the display. The directional arrow and other graphical elements help guide you towards the location object.

You will find an overview with the names of the receiver parts inside the front cover (Fig. 1).

The selected volume of the loudspeaker or headphones does not affect the sensitivity of the device, i.e. loud signals are not necessarily strong signals.









The **UT 9000 R** receiver can be used for both active and passive location. Semi-automatic gain control can be used to simplify active location.

The lower part of the receiver contains multiple antennas. The selected signal behaviour determines exactly how they combine within the device.





2.2 Location methods, location types and signal behaviour

Active and passive location with the **UT 9000** are referred to location methods.





Two different location types are available for each of the location methods. Different signal behaviours can be selected depending on the location type. The location types and signal behaviour are shown using symbols.

Location mode	Location type	Signal behaviour
active location	 sonde	 coordinates
	 line	 maximum narrow
passive location	 current	 maximum wide  minimum
	 radio	 maximum narrow

Location types









Location type	Suitable location objects
 Sonde	<ul style="list-style-type: none"> • non-metal pipes carrying a sonde
 Line	<ul style="list-style-type: none"> • lines being energised by a generator (see section 3.2 on page 22)
 Current	<ul style="list-style-type: none"> • current-carrying cables <ul style="list-style-type: none"> – available frequencies: 50 Hz, 100 Hz, 150 Hz or 60 Hz, 120 Hz, 180 Hz
 Radio	<ul style="list-style-type: none"> • metallic lines <ul style="list-style-type: none"> – available frequency: radio, i.e. frequency range 11.6 – 31.4 kHz (VLF range)







Signal behaviour

Signal behaviour	Description
 <p>Coordinates</p>	<ul style="list-style-type: none"> ● for precise location of a sonde ● for determining where fibre-optic cables end
 <p>Maximum wide</p>	<ul style="list-style-type: none"> ● to determine the location of a line using the maximum method ● in comparison to maximum narrow signal behaviour: <ul style="list-style-type: none"> – wider range – lower accuracy
 <p>Maximum narrow</p>	<ul style="list-style-type: none"> ● to determine the location of a line using the maximum method ● in comparison to maximum wide signal behaviour: <ul style="list-style-type: none"> – lower range – greater accuracy
 <p>Minimum</p>	<ul style="list-style-type: none"> ● to determine the location of a line using the minimum method (zero signal) ● significant distinct signal curve over the line

2.3 Control panel

The control panel consists of six keys (Fig. 2 inside front cover). Some keys have more than one function.

Key	Function	Action	
  Volume	<ul style="list-style-type: none"> to increase the volume or turn the sound off 	<ul style="list-style-type: none"> press key briefly several times 	
	 ON/OFF	<ul style="list-style-type: none"> to switch the device on to switch the device off 	<ul style="list-style-type: none"> press the key hold down the key
	Measuring mode	<ul style="list-style-type: none"> to close the menu and return directly to the measuring mode 	<ul style="list-style-type: none"> press the key
  Location type	<ul style="list-style-type: none"> to select the location type 	<ul style="list-style-type: none"> press the key 	
	 Depth	<ul style="list-style-type: none"> in the case of determining the depth manually: to enable the depth measurement 	<ul style="list-style-type: none"> press the key until an acoustic signal sounds
	 Back	<ul style="list-style-type: none"> in a menu: to return to the next level up 	<ul style="list-style-type: none"> press the key briefly
  Up	<ul style="list-style-type: none"> in a menu: to select or to move up 	<ul style="list-style-type: none"> press the key 	
	Gain up	<ul style="list-style-type: none"> to increase the gain 	<ul style="list-style-type: none"> press the key (semi-automatic gain control adjustment) press the key repeatedly (manual gain control adjustment)

Key	Function	Action	
 Down	<ul style="list-style-type: none"> in a menu: to select or to move down 	<ul style="list-style-type: none"> press the key 	
	Gain down <ul style="list-style-type: none"> to reduce the gain 	<ul style="list-style-type: none"> press the key (semi-automatic gain control adjustment) press the key repeatedly (manual gain control adjustment) 	
 Signal behaviour	<ul style="list-style-type: none"> to select the signal behaviour 	<ul style="list-style-type: none"> press the key briefly 	
	 Menu	<ul style="list-style-type: none"> to open a menu 	<ul style="list-style-type: none"> hold down the key
 f Frequency	<ul style="list-style-type: none"> to select a frequency 	<ul style="list-style-type: none"> press key briefly several times 	
	 Direction recognition	<ul style="list-style-type: none"> to enable direction recognition 	<ul style="list-style-type: none"> press the key until an acoustic signal sounds
	 Next	<ul style="list-style-type: none"> in a menu: to go to the next level down 	<ul style="list-style-type: none"> press the key
	Select	<ul style="list-style-type: none"> to select a setting (enable/disable) 	<ul style="list-style-type: none"> press the key

2.4 Display

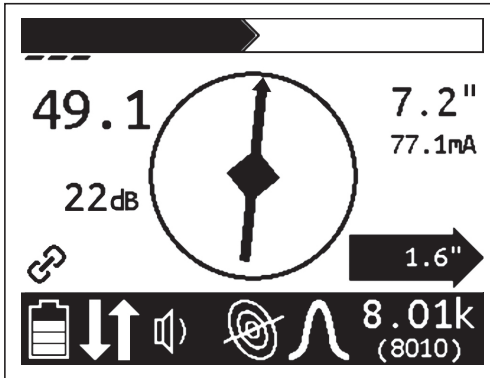

Fig. 5: UT 9000 R receiver display (overview)

The upper area displays the field strength and gain in graphical form. The lower area consists of a tool bar which displays the current settings and conditions using symbols.

The central area is used to help guide you towards the location object with the help of graphical elements. The current measurement values are displayed on the right and left-hand sides.

Field strength

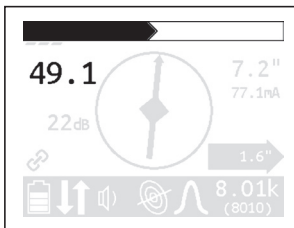

Fig. 6: Receiver display – field strength display

The field strength is displayed:

- numerically
in the example (Fig. 6): 49.1
- graphically
the larger the bar, the greater the field strength.

Gain

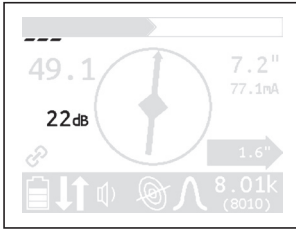

Fig. 7: Receiver display – gain display

The field strength is displayed:

- numerically
in the example (Fig. 7): 22 dB
- graphically

The more segments that are visible, the higher the gain.

Depth

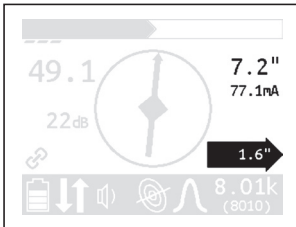

Fig. 8: Receiver display – depth and distance display

The depth is displayed numerically. The unit of measurement can be set.

in the example (Fig. 8): 7.2"

If offset depth determination is enabled, the distance to the location object is also displayed inside a black arrow.

in the example (Fig. 8): 1.6"

In addition, the current is also shown on the display. This helps for example in identifying the energised line in case of parallel lines.

in the example (Fig. 8): 77.1 mA

Graphical elements

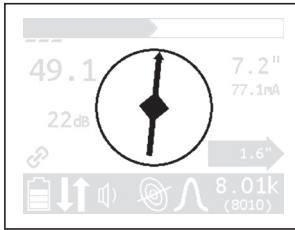
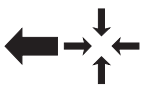

Fig. 9: Receiver display – graphical elements



Compass with needle

- the compass needles show the position of the line.



Directional arrows

- the receiver needs to be moved in the direction of the arrow shown.



Diamond

- the receiver is located directly above the location object.

When locating sondes:



Point

- the receiver is located above a minimum in the signal curve.



Turn arrows

- the receiver needs to be turned in the direction of the arrow shown.



Tips

- the tips show the position of the sonde.

Symbols

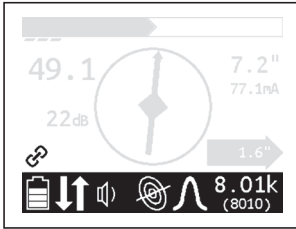

Fig. 10: Receiver display – symbols

The selected frequency is displayed twice on the right-hand side of the tool bar. For frequencies over 1,000 Hz, the top value is displayed in kHz and underneath in Hz.

Information about the generator



receiver and generator paired



generator beyond radio range



selected frequency not enabled in generator

Battery status



remaining battery capacity

Miscellaneous



direction recognition enabled

Volume



tone switched on



tone switched off

Location type



sonde



line



current



radio

Signal behaviour



coordinates



maximum narrow



maximum wide



minimum

2.5 Configuring the device (menu)

The menu can be used for making settings and for retrieving information about the device. The following menu items are available:

- **Frequencies**
- **Settings**
- **Options**
- **System Info**
- **Ambient noise**
- **TX Control**

Opening the menu

With the device switched on:

- Hold down the **menu** key. The menu appears.

Opening a menu item

With the menu open:

1. Press the **up** or **down** key. The selected menu item will be highlighted.
2. Press the **next** key. The selected menu item is opened.

Changing the settings

With the menu item for which you wish to change the settings:

1. Press the **up** or **down** key. The selected setting is highlighted.
2. Press the **next** key. The setting will be enabled/disabled.
3. Press the **back** key. The setting will be accepted. The device will be returned to the next level up.

Exiting the menu or a menu item

With the menu or a menu item open:

- Press the **back** key. The device will be returned to the next level up.

Returning directly to the measuring mode

With the menu or a menu item open:

- Press the **volume** key. The device will return directly to the measuring mode.

2.5.1 Frequencies menu item

The **Frequencies** menu item is used to enable or disable the pre-set frequencies. Symbols indicate which individual frequencies are suitable for the different location types. An explanation of these symbols can be found in section 9.2.1 on page 74.

For more detailed information on which frequencies to select, please refer to section 4.2 on page 41.

2.5.2 Settings menu item

The **Settings** menu item can be used to modify the following settings:

- **Language**
- **Units**
- **Backlight**
- **Shutdown Timer** (shutdown time)
- **Communications**

2.5.2.1 Language

The **Language** menu item is used to change the language used on the display.

2.5.2.2 Units

The **Units** menu item is used to modify the units of measurement for the distance (depth) and offset depth.

2.5.2.3 Backlight

The **Backlight** menu item is used to switch the display backlight on and off.

If the backlight is enabled (**Autom./automatic**), the display is lit up in the case of low levels of light. The sensor for this automatic control can be found on the control panel.

2.5.2.4 Shutdown Timer

The **Shutdown Timer** menu item is used to set the time after which the device should be shut down if not in use.

If **Always On** is selected, the device never shuts down automatically.

2.5.2.5 Communications

The following options are available in the **Communications** menu item:

- **Radio On/Off**
- **Bluetooth**
- **Link Info** (linking information)
- **Link TX**
- **Unlink TX**

Radio On/Off

The **Radio On/Off** menu item can be used to disconnect or re-establish the radio connection between the generator and the receiver.

An example of when it may be necessary to disconnect the radio connection is when attempting to make a secure connection to a Bluetooth device (e.g. GPS mouse).

Note:

Disconnecting the radio connection does not cut an existing pairing of generator and receiver.

Bluetooth

The **Bluetooth** menu item is used for saving location results on an external Bluetooth device (e.g. GPS mouse), making it possible to document location results.

The receiver needs to be connected to the Bluetooth device in order for data transmission to be possible. Once the data has been transmitted, the devices are disconnected again.

Pairing information

The **Link Info** menu item is used to display information on pairing with a generator.

If a receiver is paired with a generator, the device number of the generator is displayed in **Linked To**.

Link TX

The menu item **Link TX** is used to pair a receiver with a generator.

For more detailed information on pairing, please refer to section 4.1.1 on page 39.

Unlink TX

The menu item **Unlink TX** is used to unpair an existing link between a receiver and a generator.

For more detailed information on unpairing, please refer to section 4.1.1 on page 39.

2.5.3 Options menu item

The **Options** menu item can be used to modify the following:

- **Audio Mode**
- **Audio Style**
- **Gain**
- **Autodepth**
- **Offset Depth**

2.5.3.1 Audio Mode

The **Audio Mode** menu item can be used to set the acoustic signal type.

- **Pitch**

The pitch of the signal changes (up/down).

- **Volume**

The volume of the signal changes (loud/quiet).

2.5.3.2 Audio Style

The **Audio Style** menu item is used for setting which kind of sound reproduction is used.

- **Classic**
- **Smooth**

2.5.3.3 Gain

The **Gain** menu item is used to set how the gain on the received signals is readjusted. The gain control must always be readjusted by the user.

- **Manual**

Incremental gain control adjustment up to desired gain.

- **Semi-auto** (semi-automatic)

Gain control adjustment is carried out within the optional gain range.

More information about adjusting the gain can be found in section 4.3 on page 43.

2.5.3.4 Autodepth

The **Autodepth** menu item is used to set how the depth of the location object should be determined.

- **Autodepth** (automatically)

The depth is displayed automatically as soon as the device is located directly above the location object.

- **Manual**

The user need to press the **depth** key for the depth to be determined.

2.5.3.5 Offset Depth

The Offset Depth menu item can be used to enable or disable the determination of the **offset depth**.

For more detailed information on the offset depth, please refer to section 4.4.3 on page 45.

2.5.4 System Info menu item

The **System Info** menu item displays information about the device. This information may be spread across several pages.

- Press the **down** key to display all the information.

2.5.5 Ambient Noise menu item

The **Ambient Noise** menu item can be used to determine which of the enabled frequencies are present and at what strength in the surrounding areas for each location type.

For more detailed information on ambient noise, please refer to section 5.1 on page 49.

2.5.6 TX Control menu item

Note:

The **TX Control** menu item is only available when the receiver is paired with a generator.

With the help of the **TX Control** menu item, the receiver is able to control the generator in measuring mode. The generator must be switched on.

The following settings can be modified for the current location situation:

- **Power level**
- **Dual Output**, as long as a Y-cable (double set of cables) is attached to the generator.

This changes the assignment of the flow of current between the red and white cables. The cable not in use is shown as crossed out.

Information on dual output can be found in section 3.5.2.2 on page 28.

Controlling the generator via the receiver

On the receiver:

1. In the menu, select: **Settings > TX Control**.

The operating mode display appears. The symbol of the function which can be modified flashes.

- Press the **down** or **up** key to change between power level and dual output.
- Click on the **next** key to change the corresponding settings.

2. Click on the **back** key to accept the changes.

2.6 Power supply

The device can be operated with either disposable or regular rechargeable batteries.

NOTICE! Risk of damage due to leaking batteries

- Never mix power sources of different types (disposable or rechargeable), capacity, condition (new or used) or manufacturer.
-

Changing the batteries

The battery compartment cover is locked with a quick-release fastener.

1. Turn the quick-release fastener to open the battery compartment.
2. Remove the used batteries.
3. Insert new batteries. Ensure correct polarity (Fig. 11).

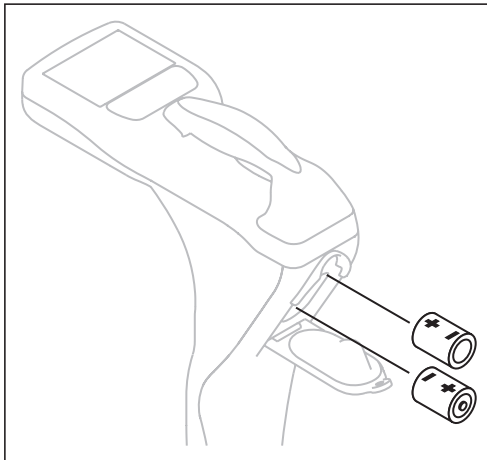

Fig. 11: Changing the batteries in the receiver – battery polarity

4. Close the battery compartment.
5. Check that the device is ready for operation by switching it on.
If the battery polarity is incorrect, the device will not switch on.

3 UT 9005 TX / UT 9012 TX generator

3.1 General

The generator can be used to energise lines both galvanically and inductively. The generator is, therefore, often also referred to as a transmitter.

Different frequencies are available for energising lines. The most common frequencies are pre-set as default settings (see section 9.2.2 on page 75).

You will find an overview with the names of the generator parts inside the front cover (Fig. 3).





When the sound is switched on, a continuous signal sounds. This signal is used to ensure the working area is safe.

The generator is available in two different models:

- **UT 9012 TX**
 - 12 watt output
- **UT 9005 TX**
 - 5 watt output
 - no external power source connector











3.2 Operating modes

The device can be used to energise lines galvanically and inductively. The selected operating mode is indicated by means of symbols.

Operating mode	Energising with
inductive energising	 cable clamp
	 generator without accessories (using internal frame coil)
galvanic energising	 set of cables (single set of cables)
	 Y-cable (double set of cables)

3.3 Control panel

The control panel consists of four keys (Fig. 4 inside front cover). Some keys have more than one function.

Key	Function	Action	
  Volume	<ul style="list-style-type: none"> to turn the tone on to turn the tone off 	<ul style="list-style-type: none"> press the key briefly 	
	 ON/OFF	<ul style="list-style-type: none"> to switch the device on to switch the device off 	<ul style="list-style-type: none"> press the key hold down the key
	 Back	<ul style="list-style-type: none"> in a menu: to return to the next level up 	<ul style="list-style-type: none"> press the key briefly
  Power Level	<ul style="list-style-type: none"> to select the power level 	<ul style="list-style-type: none"> press key briefly several times 	
	 Menu	<ul style="list-style-type: none"> to open a menu 	<ul style="list-style-type: none"> hold down the key
	 Next	<ul style="list-style-type: none"> in a menu: to go to the next level down 	<ul style="list-style-type: none"> press the key briefly
	 Select	<ul style="list-style-type: none"> to select a setting (enable/disable) 	<ul style="list-style-type: none"> press the key briefly
 f+ Frequency up	<ul style="list-style-type: none"> to increase the frequency 	<ul style="list-style-type: none"> press the key briefly 	
 f- Frequency down	<ul style="list-style-type: none"> to reduce the frequency 	<ul style="list-style-type: none"> press the key briefly 	

3.4 Display

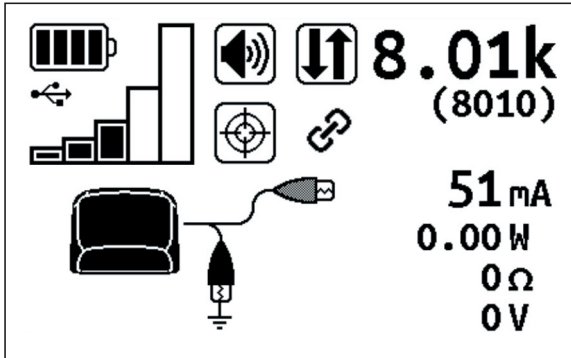

Fig. 12: UT 9012 TX generator display (overview)

The left-hand side of the display uses symbols to show the current settings and statuses. The right-hand side of the display shows the frequency and different parameters as numerical values.

Symbols

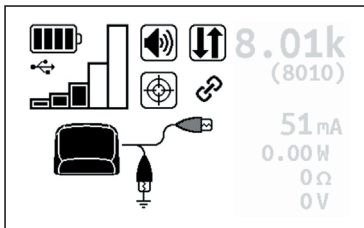

Fig. 13: Generator display – symbols

Battery status



remaining capacity of the battery or lithium-ion rechargeable battery

Connections



USB connected



external power supply

Power



selected power level



high power enabled

Volume



tone switched on



tone switched off

Generator status



generator transmitting



generator not transmitting



generator unable to transmit (connection error during galvanic energising)

Miscellaneous



direction recognition enabled



generator paired with receiver



step-voltage probe enabled

Energising with



cable clamp connected



generator without accessories (using internal frame coil)



set of cables (single set of cables) connected



Y-cable (double set of cables) connected

Frequency

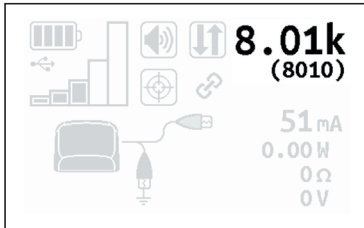

Fig. 14: Generator display – frequency display

The selected frequency is displayed twice. For frequencies over 1,000 Hz, the top value is displayed in kHz and underneath in Hz.

Parameters

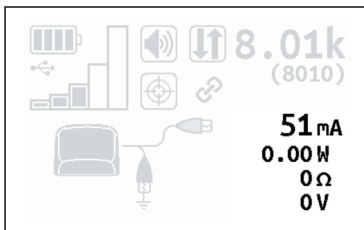

Fig. 15: Generator display – parameters

The parameters show the current generator values when energising. The values shown depend on:

- operating mode
- the settings in **Meter**

More information about the settings for meter can be found in section 3.5.2.3 on page 30.

3.5 Configuring the device (menu)

The menu can be used for making settings and for retrieving information about the device. The following menu items are available:

- **Frequencies**
- **Settings**
- **Options**
- **System Info**

Opening the menu

With the device switched on:

- Hold down the **menu** key. The menu appears.

Opening a menu item

With the menu open:

1. Press the **frequency up** or **frequency down** key. The selected menu item will be highlighted.
2. Press the **next** key. The selected menu item is opened.

Changing the settings

With the menu item for which you wish to change the settings:

1. Press the **frequency up** or **frequency down** key. The selected setting is highlighted.
2. Press the **select** key. The setting will be enabled/disabled.
3. Press the **back** key. The setting will be accepted. The device will be returned to the next level up.

Exiting the menu or a menu item

With the menu or a menu item open:

- Press the **back** key. The device will be returned to the next level up.

3.5.1 Frequencies menu item

The **frequencies** menu item is used to enable or disable the pre-set frequencies. Symbols indicate which individual frequencies are suitable for the different operating modes.

An explanation of these symbols can be found in section 9.2.1 on page 74.

For more detailed information on which frequencies to select, please refer to section 4.2 on page 41.

3.5.2 Settings menu item

The **settings** menu item can be used to modify the following settings:

- **Backlight**
- **Output**
- **Meter**
- **Communications**

3.5.2.1 Backlight

The **Backlight** menu item is used to switch the display backlight on and off.

If the backlight is enabled (**ON**), an additional menu item appears: **Timer**. This menu item can be used to set the time after which the backlight is automatically switched off if the device is temporarily not in use. Default: 5 seconds.

3.5.2.2 Output

Note:

The **Output** menu item is only available when a set of cables is connected to the generator. The set of cables must be connected before opening the menu.

The **Output** menu item can be used to set special functions for the output signal. The following menu items are available:

- **Direction Enabled** (direction recognition)
- **High Power**
- **Dual Output** (Y-cable)

Direction Enabled

The **Direction Enabled** menu item is used to enable direction recognition.

For more detailed information on direction recognition, please refer to section 5.4 on page 58.

High Power

The **High Power** menu item is used to set the generator to energise with an output power of 12 W for a specified time.

When the **High Power** function is enabled, a **Timer** can be set to specify how long the generator should be energised at 12 W. Default: 5 minutes.

For more detailed information on this function, please refer to section 5.5 on page 60.

Dual Output

When working with a parallel connection, we need to specify which of the cables in a Y-cable (double set of cables) is primarily enabled and which is blocked during energising. This pre-allocation can be set in the **Dual Output** menu item.

For more detailed information on parallel connections and pre-allocation, please refer to section 5.2.1.1 on page 53.

3.5.2.3 Meter

The **Meter** menu item is used to specify which values are shown on the display in the parameter area (Fig. 15).

Operating mode		Meter	
		Simple	Advanced
inductive energising	with cable clamp	<ul style="list-style-type: none"> • current [mA] 	<ul style="list-style-type: none"> • current [mA] • voltage [V]
	generator without accessories	<ul style="list-style-type: none"> • power percentage based on output power [%] 	<ul style="list-style-type: none"> • power percentage based on output power [%] • voltage [V]
galvanic energising		<ul style="list-style-type: none"> • current [mA] 	<ul style="list-style-type: none"> • current [mA] • power output [W] • resistance [Ω] • voltage [V]

3.5.2.4 Communications

The following options are available in the **Communications** menu item:

- **Radio On/Off**
- **Link RX**
- **Un-Link RX**
- **Link Information** (pairing information)

Radio On/Off

The **Radio On/Off** menu item can be used to disconnect or re-establish the radio connection between the generator and the receiver.

An example of when it may be necessary to disconnect the radio connection is when attempting to make a secure connection to a Bluetooth device (e.g. GPS mouse).

Note:

Disconnecting the radio connection does not cut an existing pairing of generator and receiver.

Link RX

While the receiver and generator are paired, information on the status of the connection is displayed in the **Link RX** menu item.

For more detailed information on pairing, please refer to section 4.1.1 on page 39.

Un-Link RX

The menu item **Un-Link RX** is used to unpair an existing link between a generator and a receiver.

For more detailed information on unpairing, please refer to section 4.1.1 on page 39.

Pairing information

The **Link Information** menu item is used to display information on pairing with a receiver.

If a generator is paired with a receiver, the device number of the receiver is displayed in **RX Name**.

3.5.3 Options menu item

The **Options** menu item can be used to modify the following:

- **Language**
- **Defaults**
- **Fault Mode** (step-voltage probe)

3.5.3.1 Language

The **language** menu item is used to change the language used on the display.

3.5.3.2 Defaults

Use the **Defaults** menu item to return the following settings to factory defaults:

- **Settings** (backlight, output, meter, communications)
- **Options** (language, fault mode)

Note:

The default language setting for the device is English: be aware that all text on the display will appear in English after returning to factory settings.

Resetting the defaults

1. Open the **Defaults** menu item. A warning prompt will appear.
2. If you really wish to reset the default values, press the **frequency up** key. The **OK** field is highlighted.
3. Press the **select** key. The settings are now returned to their defaults.

3.5.3.3 Step-voltage probe

Note:

The **Fault Mode** menu item is only available when a set of cables is connected to the generator. The set of cables must be connected before opening the menu.

The **Fault Mode** menu item is used to enable or disable a step-voltage probe.

Step-voltage probes are used to measure cable faults. **FF** (Fault Finder) will appear on the display instead of the frequency when a step-voltage probe is enabled.

The step-voltage probe can be purchased additionally as an accessory.

3.5.4 System info menu item

The **System Info** menu item displays information about the device. This information may be spread across several pages.

- Press the **frequency down** key to display all the information.

3.6 Power supply

Both internal and external power supplies can be used to provide power.

Internal power supply

The device can be operated with either disposable or rechargeable lithium-ion batteries.

Different battery compartment covers (Fig. 16) are required depending on which kind of battery is used.

Power source	Battery compartment feature
Disposable batteries	Battery holder for ten batteries inside the battery compartment
Lithium-ion rechargeable battery	Rechargeable battery integrated into battery compartment

The battery compartment covers have a sticker on the outside which specifies the power supply.



Fig. 16: A generator with the battery compartment open (upper image). Both battery compartment covers with disposable batteries (bottom left) or with an integrated rechargeable lithium-ion battery (bottom right) can be used.

External power supply

The external power supply is connected via a vehicle cable.

Whenever a power source (e.g. external rechargeable battery) is connected to the external power supply, the internal power supply is cut off.

3.6.1 Changing the batteries

Ten disposable D/LR20 alkaline batteries are required to power the device.

NOTICE! Risk of damage due to leaking batteries

- Never mix power sources of different types (disposable or rechargeable), capacity, condition (new or used) or manufacturer.
-

The battery compartment cover is locked with quick-release fasteners.

1. Turn the quick-release fasteners to open the battery compartment.
2. Remove the used batteries.
3. Insert new batteries. Ensure correct polarity (Fig. 17).

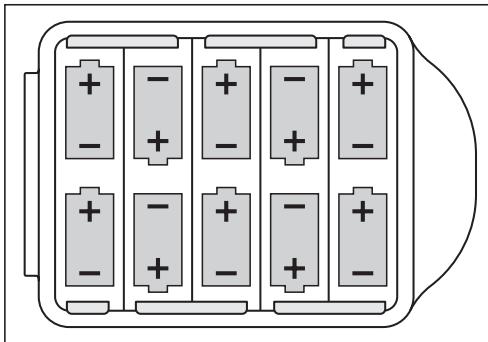

Fig. 17: Changing the batteries in the generator – battery polarity

4. Close the battery compartment.
5. Check that the device is ready for operation by switching it on.
If the battery polarity is incorrect, the device will not switch on.

3.6.2 Lithium-ion rechargeable battery

A special lithium-ion rechargeable battery is required to power the device.

The lithium-ion rechargeable battery can be purchased additionally as an accessory.

3.6.2.1 Safety information regarding the lithium-ion rechargeable battery

- Danger of short-circuit! Do not touch the power connector poles with metallic objects.
- Never attempt to open the rechargeable battery.
- Never use a damaged rechargeable battery.
- Prevent humidity from entering the rechargeable battery.
- Ensure the correct conditions when charging, storing and operating the battery.

Ensure special protection against very high or low temperatures.

- Protect the battery from mechanical stress (knocks, vibration). Never drop the battery.
- Never dispose of the battery in a fire.
- Always dispose of rechargeable batteries in accordance with local regulations.

3.6.2.2 Storage of the rechargeable battery

If the rechargeable battery is to be stored for a long period of time, certain preventive and care measures need to be taken during storage.

Storage conditions	
ideal	<ul style="list-style-type: none">● temperature < 21 °C● dry environment● ambient air free of corrosive gases
permissible	<ul style="list-style-type: none">● temperature -20 °C to 50 °C● relative humidity < 80 %

Note:

The device can be stored temporarily up to a temperature of 50°C, however prolonged exposure to temperatures above 45 °C will reduce the battery's performance and life.

NOTICE! Danger of battery destruction

Rechargeable batteries which have completely lost their charge cannot be recharged.

- Before storage, charge or discharge the rechargeable battery to around 30 – 50 % capacity.
- Always store the battery in optimum storage conditions.
- Recharge the battery every 6 months in order to ensure it never self-discharges entirely. Only ever charge the rechargeable battery to around 30 – 50 % capacity.

3.6.2.3 Charging the battery

The rechargeable battery is integrated into battery compartment cover. There is a charging socket on the long side of the battery compartment cover.

NOTICE! Danger of battery destruction

The rechargeable battery has a dedicated adapter.

- Only use the **UT 9000 AC/DC adapter** to charge the battery.
 - Before using the AC/DC adapter to charge the battery, ensure it is in perfect condition. Never use a damaged AC/DC adapter.
 - Always observe the permitted charging conditions: temperature 0 °C – 45 °C, relative humidity < 80 %.
-

The battery compartment cover is locked with quick-release fasteners.

1. Turn the quick-release fasteners to open the battery compartment. Remove the battery compartment cover with the integrated rechargeable battery.
-

2. Connect the rechargeable battery to a suitable power source using the AC/DC adapter.

The battery will be charged. The LED on the AC/DC adapter will display the current charging status:

LED	State of charge
red	battery charging
green	battery fully charged (charging process completed) Note: The LED will still be green when the power supply is connected to the mains, even if the rechargeable battery is not connected to the charging unit.

3. Once the battery is fully charged, remove it from the power supply.
4. Replace the battery compartment cover into the battery compartment. Close the battery compartment.

4 Using the UT 9000 system

4.1 Device pairing

For active location, a receiver needs to be assigned to a generator so that the two form a device pair. To do so, the receiver and generator are linked. The device number is the means of identification.

Existing device pairings can be removed and the devices can then be paired once again or different devices can be paired.

4.1.1 Pairing the generator and the receiver

During the pairing process, a generator is assigned to a receiver. Only paired devices can communicate via radio.

Note:

the connection between the receiver and the generator can only be established from the receiver.

1. On the generator:
 - In the menu, select:
Settings > Communications > Link RX.
2. On the receiver:
 - a) In the menu, select:
Settings > Communications > Link TX.
 - b) Wait until the initialisation process is complete.
 - c) Press the **next** key. The search for suitable devices begins.
A message appears with how many suitable devices have been found in the area. The compatible devices are then shown alongside their device numbers.
 - d) Select the desired device.
 - e) Press the **next** key. The pairing is established.
Once the receiver and generator have been paired successfully, a message appears.

Once the receiver and generator are paired, the measuring mode display on each device shows the paired symbol.

4.1.2 Disconnecting the generator and the receiver

In order to disconnect an existing device pairing, each device must be disconnected separately.

1. On the generator:
 - a) In the menu, select:
Settings > Communications > Unlink RX. A prompt will appear.

Note:

The prompt will even appear if there is no pairing between the generator and receiver.

- b) Press the **frequency up** key if you really want to disconnect the devices. The **OK** field is highlighted.
 - c) Press the **select** key. The pairing is disconnected.
The paired symbol no longer appears on the display in measuring mode.
 - d) Switch the generator off and then back on again.
2. On the receiver:
 - a) In the menu, select:
Settings > Communications > Unlink TX. A prompt will appear.
 - b) Press the **down** key if you really want to disconnect the devices. The **Unlink** field is highlighted.
 - c) Press the **next** key. The pairing is disconnected.
The paired symbol no longer appears on the display in measuring mode.
 - d) Switch the receiver off and then back on again.

4.2 Frequency selection

Frequencies can be available, pre-set and enabled. Only enabled frequencies can be used for location.

- **Available frequencies**

75 different frequencies are available in the system.

An overview of the available frequencies can be found in the appendix (section 9.2 on page 74).

- **Pre-set frequencies**

The pre-set frequencies are a selection of all of the available frequencies.

All pre-set frequencies can be found on the devices in the menu under **Frequencies**.

The most common frequencies are pre-set as default settings. If other, additional frequencies are required, they must be set up on the system using the **UT 9000 software**.

- **Enabled frequencies**

Enabled frequencies are a selection of all of the pre-set frequencies.

Only enabled frequencies can be used for location. Frequencies which are not required can be disabled.

4.2.1 Enabling a frequency

Note:

SEWERIN recommends enabling any eligible frequencies before starting the location process in order to successfully determine the ambient noise.

The required frequencies must be enabled on both the generator and the receiver.

1. On the generator:

a) In the menu, select: **Frequencies**

b) Enable the required frequencies. Where applicable, disable any unrequired frequencies.

Pay attention to the suitability of the different frequencies for certain operating modes.

2. On the receiver:

a) In the menu, select: **Frequencies**

b) Enable the required frequencies. Where applicable, disable any unrequired frequencies.

Pay attention to the suitability of the different frequencies for certain location types.

4.2.2 Selecting the frequencies

Optimum results are only possible when the correct frequency is set.

In the case of the location type **Sonde**, the frequency on the receiver must correspond with the frequency of the location object.

The frequency can be modified during the location process in the following location types until the optimum frequency is found:

- **line** (active location)
- **current** (passive location)

All enabled frequencies will be available for selection.

Note:

SEWERIN recommends beginning the location process with a suitable frequency.

- Always determine the ambient noise before starting (see section 5.1 on page 49).
-

The frequency can be modified on either the receiver or the generator. NB:

- If the frequency is changed on the receiver, it will automatically be modified on the paired generator.
- If the frequency is changed on the generator, however, it must be modified manually on the receiver.

The following keys are used to change the frequency:

- On the receiver: **frequency**
- On the generator: **frequency up** or **frequency down**

4.3 Gain control on the receiver

During the location process, the signal reception can be inadequate or excessive. This effect can be counterbalanced by adjusting the gain.

In the case of gain:

- high gain > high signal sensitivity: location can be carried out further away from the generator
- low gain > low signal sensitivity: may reduce excessive signal strength

The gain can be controlled either manually or semi-automatically according to the settings (see section 2.5.3.3 on page 18).

Manual adjustment of gain

- Press the **gain up** key several times or hold it down to increase the gain.
- Press the **gain down** key several times or hold it down to reduce the gain.

Semi-automatic adjustment of gain

The gain is optimised automatically when you press the key.

- Press the **gain up** key once if the gain is too low.
- Press the **gain down** key once if the gain is too high.

4.4 Depth measurement

The depth specifies the distance from the bottom edge of the receiver and the middle of the line. When locating sondes, the depth shown refers to the middle of the sonde.

Note:

Please note before any excavation that the depth always refers to the centre of the electromagnetic field. The top edge of large lines, therefore, may not be as deep as specified.

Units

The depth can be displayed in various units.

The unit of measurement can be set in the menu under **Settings > Units**.

Depth measurement type

The depth can either be determined automatically or manually.

The type of depth measurement can be set in the menu under **Options > Autodepth**.

4.4.1 Determining the depth automatically

If automatic depth measurement is set, the depth is displayed as soon as the receiver is located above the location object.

If the receiver is not located above the location object, no value is displayed for the depth.

Note:

In the case of very uneven surfaces, it is not always possible for the device to determine the depth, however in such cases it is always possible to determine the depth manually.

4.4.2 Determining the depth manually

If manual depth measurement is set, the **depth** key needs to be pressed until the unit emits a beep.

4.4.3 Determining the offset depth

In addition to simple depth measurement, the so-called offset depth can also be calculated. In this case, the device also determines the distance to the location object as well as its depth.

This function is useful if

- obstacles above the line in question prevent a direct depth measurement
- the plausibility of results for a simple depth measurement should be checked

The offset depth is determined by triangulation. The display shows the following:

- the distance X from the receiver to the location object
- the depth D of the location object

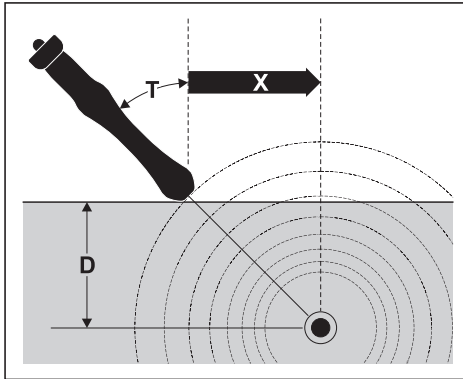

Fig. 18: Determining the offset depth
D depth
X distance receiver – location object
T tilt angle of the receiver

The settings in **Options > Autodepth** are used to specify whether the offset depth is displayed automatically or determined manually.

1. Enable the **Offset Depth** function.
To do so, select the following in the menu: **Options > Offset Depth > On**.
2. Locate a line.
3. Hold the receiver as parallel as possible to the assumed route of the line.
4. Tilt the receiver to an angle T of between $10^\circ - 60^\circ$ (Fig. 18).
5. Once directional arrows appear on the screen:
 - move the receiver according to the directional arrows shown.
 - while doing so, vary the tilt angle of the receiver.The directional arrows change into a diamond once the receiver is in an optimum position.
6. The values for the depth and distance are now shown
 - automatically if automatic depth measurement is set
 - upon pressing the **depth** key if manual depth measurement is set

4.5 UT 9000 software

The **UT 9000 software** is used to update and configure devices in an efficient manner. Individual settings can be stored in a file for future use.

Requirements:

- the software must be installed on a computer
- the device (receiver or generator) must be connected to the computer via a USB cable

The software is used to carry out the following tasks:

- updating the firmware
- pre-setting the frequencies
- enabling the frequencies
- configuring the device (according to menu items **Settings** and **Options**)
- setting up the start screen (e.g. adding a company logo)

The software can be downloaded free of charge from www.sewerin.com (Products > Downloads > Software). A notification is displayed if there is an update available for the software.

Updating or configuring the device via the software

1. Remove the cover to the USB connection on the device.
2. Connect the device to the computer using a USB cable.
3. Launch the software.
4. Click on **Connect** on the **Software Update** tab. The device should now be recognised by the software.
5. Perform the required tasks in the software.
6. Disconnect the device from the computer.
7. Ensure that the USB cover on the device is closed properly to make sure that no humidity can enter.

NOTICE! Possibility of destroying thread when replacing screws

The cover to the USB connection is adapted to the contour of the **UT 9000 R** receiver.

- Ensure that the cover is replaced correctly.
-

8. If necessary, update or configure other devices.
9. Close the software.

5 Active location: lines

In active location, a generator is used to produce an electromagnetic field around the line to be located. The energised line can then be located.

Carry out the following steps to locate a line using active location:

1. determine the ambient noise
2. energise the line
3. locate the line

5.1 Determining the ambient noise

Lines are often surrounded by frequencies which can make location more difficult (interference signals). The ambient noise needs to be determined in order to be able to select a suitable frequency for energising and locating the line despite these interferences. The process consists of the receiver testing which enabled frequencies are found in the surroundings and at what strength.

Ambient noise can only be determined in the following location types:

- **line** (active location)
- **current** (passive location)

Suitability of a frequency for location

Location mode	Location type	Signal strength (interference signal)	
		high	low
active	line	☹️ unsuitable frequency	😊️ suitable frequency
passive	current	😊️ suitable frequency	☹️ unsuitable frequency

Note:

The decision on which of the suitable frequencies is actually used for subsequent energising and locating assumes corresponding expert knowledge.

1. Ensure that the generator is switched off.
2. On the receiver:
 - a) Select the location type: **Line**.
 - b) In the menu, select: **Ambient Noise**.
3. If more than eight frequencies are enabled:
 - press the **down** key in order to scan further frequencies.
4. Select a frequency from one of the suitable options.
5. Press the **back** key.

The selected frequency is now used for location. If the frequency is enabled in the generator, the receiver sends the frequency by radio to it.

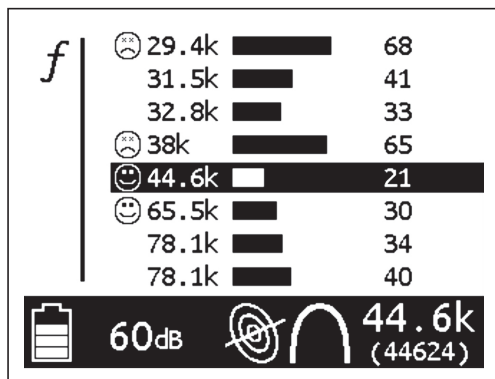

Fig. 19: Receiver display – ambient noise
The strength of the signals is displayed both as a bar (middle) and value (right).

5.2 Energising a line

In active location the line is galvanically or inductively energised.

5.2.1 Galvanic energising

Galvanic energising involves supplying power from a generator to the line via a cable. This is only possible if an electrical connection can be made at an exposed part of the line.

Energising requires a generator and a set of cables.

Sets of cables come in simple and double models. Double cables, also known as Y-cables, are used in parallel connections (see section 5.2.1.1 on page 52).

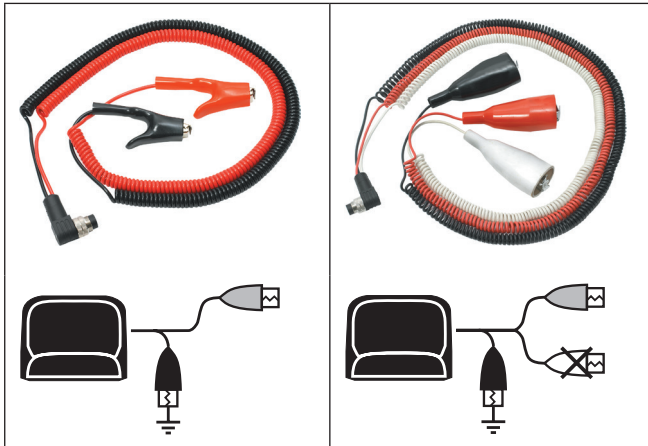

Fig. 20: Simple set of cables (left) and Y-cable (right) with the corresponding symbol below.

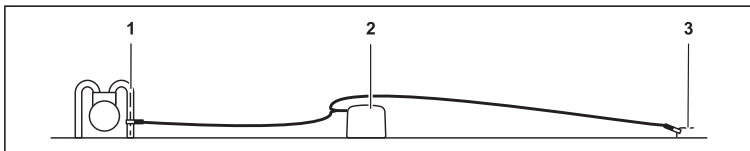

Fig. 21: Arrangement of the devices for galvanic energising
 1 Electrical connection at the line to be located, 2 Generator,
 3 Earthing spike
 The connection between the three terminals is established using a set of cables.



WARNING! Risk of injury from high voltage

High voltages can occur at exposed parts of lines.

- Carry out the instructions in the specified order.
 - Always switch off the generator before moving the earthing spike.
-

With the generator switched off:

1. Firmly stick an earthing spike into the ground.
If possible, position the earthing spike at an angle of 90° to the line.
 2. Connect the phone jack from the set of cables to the generator (port for accessories).
 3. Connect the black cable from the set of cables to the earthing spike.
 4. Connect the red cable from the set of cables to the line to be energised.
-



CAUTION! Risk of accident in the work area

Equipment and cables lying on the ground can cause a tripping hazard.

- Secure the entire work area to prevent access by third parties.
-

5. Switch on the generator.
6. Select a suitable power level.
The line is energised with the selected power.

5.2.1.1 Parallel connection

In a so-called parallel connection, two lines are connected simultaneously to the generator using a Y-cable (double set of cables).

The Y-cable (double set of cables) can be purchased additionally as an accessory.

The receiver can then control via radio which of the two connections, i.e. which line, is energised. The other connection is then de-energised. This process saves time as the connections do not need to be repeatedly changed.

Note:

Lines connected in parallel cannot be energised simultaneously.

When working with a parallel connection, the following parameters need to be set:

- Pre-allocation



Pre-allocation specifies which of the two cables in the Y-cable carries current at the start of a location process and which is blocked.

- Assignment

The **TX Control** on the receiver is used for changing which cable of the Y-cable carries current and which is blocked.

For more information on **TX Control**, please refer to section 2.5.6 on page 19.

Pre-allocation of the cables (reset)

Colour of cable	Assignment	Symbol
black	earth	
red	current	
white	blocked	

Changing the pre-allocation

On the generator:

1. In the menu, select: **Settings > Output > Dual Output > Enabled > Output Select.**
2. Select the cable which should be pre-allocated as the current-carrying cable.

5.2.1.2 Points to note when changing the set of cables

A set of cables connected to the generator is recognised by the system and shown on the generator's display via a symbol (Fig. 20).

If a simple cable is swapped for a Y-cable (double set of cables), this recognition needs to be carried out manually.

On the generator:

1. In the menu, select: **Settings > Output > Dual Output**.
 - Select **Enabled** if a Y-cable (double set of cables) is connected.
 - Select **Disabled** if a simple set of cables is connected.
2. Check that the correct symbol is displayed on the screen.

5.2.2 Inductive energising

Inductive energising involves positioning the generator above the line to be located. The electromagnetic field generated by the generator causes a current flow in the line to be located.

Energising only requires a generator. The line must be metallic.

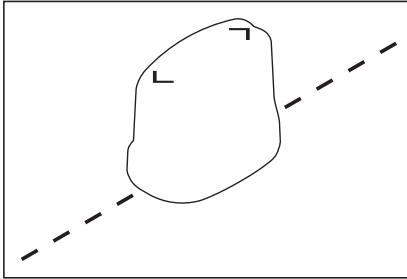

Fig. 22: Orientation of the generator in relation to the line for inductive energising

With the generator switched off:

1. Position the longitudinal axis of the generator parallel to the line to be located (Fig. 22).

The angle between the line and the longitudinal axis of the device must not exceed 15° .



CAUTION! Risk of accident in the work area

Equipment and cables lying on the ground can cause a tripping hazard.

- Secure the entire work area to prevent access by third parties.

2. Switch on the generator.
3. Select a suitable power level.

The line is energised with the selected power.

5.2.2.1 Energising with a cable clamp

Individual cables can be energised selectively using a cable clamp. Unlike galvanic energising, this does not require a direct connection to the cable and the cable does not need to be exposed.

Energising requires a generator and a cable clamp.



NOTICE! Risk of injury from high voltage

If the cable clamp is connected to a single core of a power cable, high voltages can occur in the cable clamp. These voltages can lead to shock currents or can destroy the receiver.

- Only use the cable clamp if you are certain that the current in the power cables does not exceed 300 A.
-

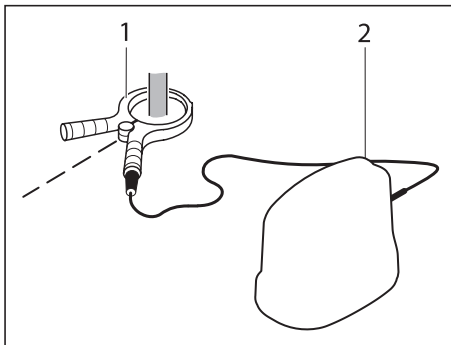

Fig. 23: Arrangement of the devices for energising with a cable clamp
1 cable clamp, 2 generator

With the generator switched off:

1. Connect the cable from the cable clamp to the generator.
2. Attach the cable clamp to the cable to be located.
Follow the operating instructions for the cable clamp.
3. Switch on the generator.
4. Select a suitable power level.

The line is energised with the selected power.

5.3 Locating a line

With the line energised:

1. Switch on the receiver.
2. Choose the following settings:
 - location type: **Line**
 - signal behaviour: **Maximum narrow**, **Maximum wide** or **Minimum**
3. Hold the receiver vertically downwards.
4. Locate the line. Evaluate the response by the receiver.

Note:

When locating inductively energised lines, it is possible to mistakenly locate the generator's own magnetic field.

- When locating inductively energised lines, always keep the receiver about 15 m away from the generator.
-

Response from the receiver when locating a line

Audio	maximum directly above the line *
Field strength	maximum directly above the line *
Gain	readjust as required, possibly several times
Directional arrows	change into a diamond directly above the line *
Compass needles	show the position of the line *
Depth	in the case of measuring the depth manually: value appears as soon as the receiver is located directly above the line *
Current	current running along the line * is greater than the current on a neighbouring line onto which the current signal has "jumped"

* i.e.: the line to be located

5.4 Direction recognition

Lines may be incorrectly located if there are additional lines running close to the one to be located. The reason for this is that neighbouring lines may also be energised unintentionally.

The direction recognition function can be used to avoid locating incorrect lines.

- The current flows away from the generator on the line to be located, i.e. the line being energised.
- The current flows towards the generator on a line to which the current "jumps".

The direction of the current is shown on the receiver by an arrow on the compass needles when direction recognition is enabled.

This function is only available for:

- location type: **Line**
- frequencies between 8 kHz and 10 kHz

1. Enable direction recognition on the generator.

a) Connect a set of cables to the generator.

b) In the menu, select: **Settings > Output > Direction Enabled > Enabled**.

The **direction recognition enabled** symbol appears on the generator display.

2. Choose the following settings on the receiver:

– location type: **Line**

– signal behaviour: **Maximum narrow, Maximum wide or Minimum**

– a frequency between 8 kHz and 10 kHz

The **direction recognition enabled** symbol appears on the receiver display.

3. Press the **direction recognition** key on the receiver until you hear a beep.

An arrow on the compass needles shows the direction the current is flowing.

4. Locate the line.

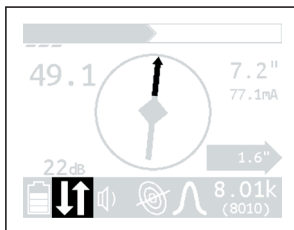

Fig. 24: Receiver display – direction recognition display

Note:

- If a frequency of less than 8 kHz or greater than 10 kHz is selected during measuring mode, the function is switched off automatically. If a frequency between 8 kHz and 10 kHz is then subsequently selected, the function is automatically switched back on.
 - Direction recognition is not available on the receiver if the **High Power** function is enabled on the generator.
-

5.5 High Power

The **UT 9012 TX** generator has a maximum output power of 12 W. In order to reduce power consumption, in normal measuring mode its highest power level is 7 W. The **High Power** function is used to set the generator to energise with an output power of 12 W for a specified time.

Note:

The **High Power** function is not available on the **UT 9005 TX** generator.

This function is particularly useful for locating across large distances.

This function is only available for:

- operating mode: **Galvanic energising**
- frequencies below 10 kHz

The function is only enabled in the generator.

1. In the menu, select: **Settings > Output > High Power > Enabled**.
2. The default setting is that the generator will energise at 12 W for a period of 5 minutes.

If required, set a longer value under **Timer**.

The **High Power** symbol appears on the display.

Note:

- SEWERIN recommends the following for frequent or prolonged use of the **High Power** function:
Use a lithium-ion rechargeable battery or an external power source to power the generator.
 - The function is only available for frequencies below 10 kHz.
 - The function can only be enabled for the current set frequency. If the frequency is modified during measuring mode, the function switches off automatically. In order to be able to use the function once more, it needs to be re-enabled.
-

6 Active location: sondes

Lines that are not electro-conductive can be located using sondes which are placed in the line. When switched on, sondes generate an electromagnetic field which can be located by the receiver.

Sondes come in different shapes and sizes. They can also be integrated into cameras for performing line diagnostics.

1. Switch on the sonde. Further information can be found in the sonde operating instructions.
2. Switch on the receiver.
3. Choose the following settings on the receiver:
 - location type: **Sondes**
 - signal behaviour: **Coordinates**
 - frequency

Note:

The frequency selected on the receiver must coincide with the frequency of the sonde.

4. Check that the sonde is working and can be located by the receiver by performing a location test outside of the line.
5. Insert the sonde into the line to be located.
6. Hold the receiver vertically downwards.
7. Locate the sonde by checking the response from the receiver (Fig. 25).

Response from the receiver when locating a sonde

Audio	maximum directly above the sonde
Field strength	maximum directly above the sonde
Gain	readjust as required, possibly several times
Directional arrows	change into a diamond directly above the sonde
Tips	show the position of the sonde
Depth	in the case of measuring the depth manually: value appears as soon as the receiver is located directly above the sonde

Note:

When locating sondes, the depth shown refers to the middle of the sonde. Note that in general this does not coincide with the middle of the line.

	Approach	Alignment	Measuring the position and depth
signal curve			
location situation			
display on the receiver screen			

Fig. 25: Steps involved in locating a sonde

7 Passive location

Passive location uses electromagnetic fields that are already present on a line to be located. Only the receiver is needed for location.

The following frequencies can be used for location:

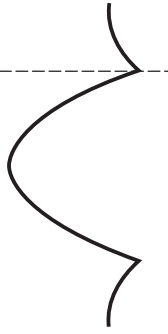
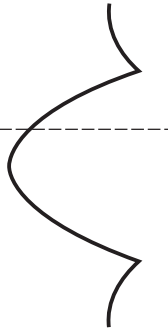
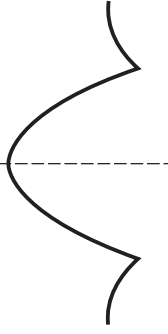
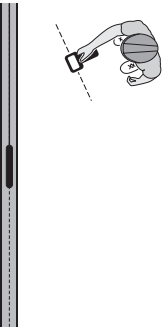
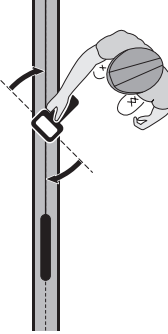
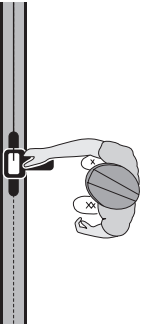
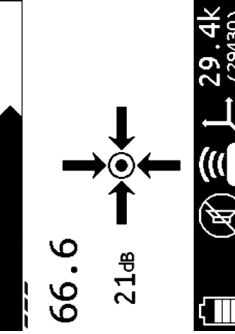
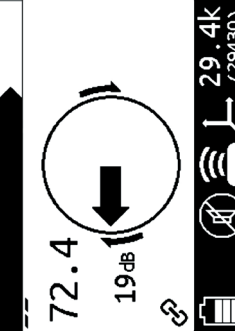
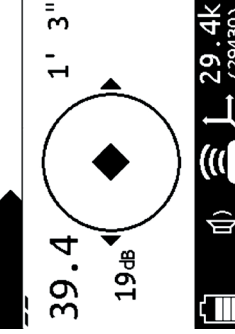
- 50 Hz, 100 Hz, 150 Hz (power line frequency in Europe)
- 60 Hz, 120 Hz, 180 Hz (power line frequency in North America, etc.)

Note:

SEWERIN recommends determining the ambient noise before starting the passive location process. For more detailed information on ambient noise, please refer to section 5.1 on page 49.

Please note that the results need to be interpreted differently from the results obtained during active location:

- in the case of passive location, the frequency with the strongest signal is the most suitable for location.
-

1. Switch on the receiver.
2. Select the location type **Current** or **Radio** using the **menu** key.
3. Hold the receiver vertically downwards.
4. Move around the site as shown in Fig. 26.

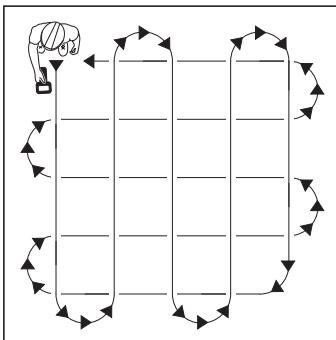

Fig. 26: Path to follow for passive location

5. As soon as you receive a corresponding signal, hold the receiver with the handle parallel to the assumed route of the line (Fig. 27).



Fig. 27: Receiver oriented to the assumed route of the line for passive location

6. Locate the line by checking the response from the receiver.

Response by the receiver during passive location

Audio	maximum or minimum directly above the line *
Field strength	maximum or minimum directly above the line *
Gain	readjust as required, possibly several times
Depth	in the case of measuring the depth manually: location type Current , frequency 50 Hz: value appears as soon as the receiver is located directly above the line *

* i.e.: the line to be located

Points to note when working with the radio location type

Note the following points when locating with the **Radio** location type rather than the **Current** location type and active location:

Signal behaviour only available for **maximum narrow**

Gain only manual

Display only gain and field strength visible
(Fig. 28)

Acoustic signals no modulation
– sounds like signal noise

Field strength strength high over the line to be located
– as soon as the receiver moves only slightly away from the line to be located, the field strength drops considerably.

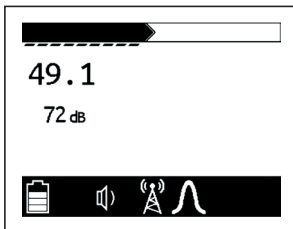

Fig. 28: Receiver display – passive location in radio location type

8 Troubleshooting

8.1 Sources of error when locating

Interference fields are the most common sources of error. Interference fields can distort the electromagnetic fields along the line, thus producing erroneous location results. This can apply to both the position and the depth of the line or sonde.

Electromagnetic fields that are too weak or distorted can also lead to incorrect location results. Distorted fields occur, for example, when other lines cross the line to be located or at junctions and bends.

Adjacent lines

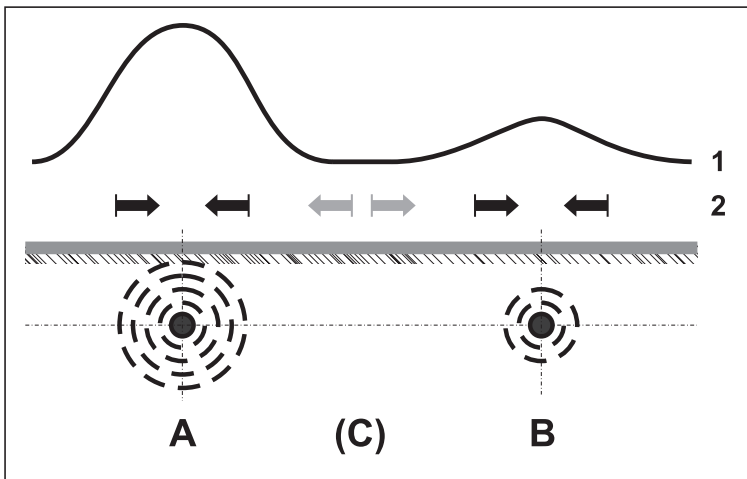

Fig. 29: Location situation with adjacent lines
 A Line to be located (galvanically energized), B Additional line,
 1 Signal curve, 2 Directional arrows

Fig. 29 shows a location situation with an additional line B close to the line to be located, line A. Line A is galvanically energized. The signal curve (1) shows a maximum above each line.

Users who primarily use acoustic location can sometimes locate a fictitious line C between line A and line B.

It is possible to avoid this error by checking carefully the directional arrows on the display. The directional arrows show the direction in which a line is located. Directly over a line the directional arrows turn into a diamond. As C is not a line, no diamond appears.

8.2 Problems with the receiver

Problem	Possible cause	Corrective action
Cannot switch on receiver	Remaining battery capacity too low	<ul style="list-style-type: none"> • Change the batteries • Charge the batteries
	Power supply interrupted	<ul style="list-style-type: none"> • Check battery contact
Receiver does not respond when switched on	Receiver faulty	<ul style="list-style-type: none"> • Remove and replace the batteries > attempt to switch receiver on once more
	Remaining battery capacity too low	<ul style="list-style-type: none"> • Change the batteries
No acoustic signal audible	Tone switched off or volume setting too low	<ul style="list-style-type: none"> • Increase volume
Display shows unusually fluctuating values	Interference fields present	<ul style="list-style-type: none"> • Eliminate interference fields: e.g. switch off computers, monitors, light dimmers, industrial appliances
Active location: Field strength overloaded (with minimum gain)	Receiver too close to generator	<ul style="list-style-type: none"> • Move receiver away from generator

8.3 Problems with the generator

Problem	Possible cause	Corrective action
Cannot switch on generator	Remaining battery capacity too low	<ul style="list-style-type: none"> • Change the batteries • Charge rechargeable battery • Use the external power source
Generator does not transmit when switched on	Generator faulty	<ul style="list-style-type: none"> • Check that the generator is working correctly: switch on the generator and receiver > measure the ambient noise: the frequency set on the generator must be picked up by the receiver with a significantly stronger signal strength.
	Remaining battery capacity too low	<ul style="list-style-type: none"> • Change the batteries • Charge rechargeable battery • Use the external power source
Galvanic energising not working	Line is not electro-conductive	<ul style="list-style-type: none"> • UT 9000 is unsuitable > use a different device or location method
	Electrical circuit interrupted	<ul style="list-style-type: none"> • Move earthing spike
	Not enough or no current flowing through the line to be located	
	Cable set faulty	<ul style="list-style-type: none"> • Replace cable set
	Cable set not connected correctly	<ul style="list-style-type: none"> • Check cable set connection
Inductive energising not working	Generator not positioned correctly above the line to be located	<ul style="list-style-type: none"> • Reposition the generator
Generator switches off during the location process	Insufficient power supply	<ul style="list-style-type: none"> • Choose a lower power level • Change the batteries

9 Appendix

9.1 Technical data

9.1.1 UT 9000 R receiver

Device data

Dimensions (W × D × H):	120 × 325 × 705 mm
Weight	2.2 kg incl. batteries

Certificates

Certificate	FCC, IC, CE
Marking	Contains FCC ID: QQQWT41 IC: 5123-BGTWT41

Features

Display	Graphic liquid crystal display with LED back-light and light sensor
Interface	USB
Controls	Membrane keypad with 6 keys

Operating conditions

Operating temperature	-20 °C – +50 °C
Storage temperature	-32 °C – +70 °C
Humidity	10 % – 90 % r.h., non-condensing
Atmospheric pressure	950 – 1,100 hPa
Protection rating	IP65
Non-permitted operating environments	in potentially explosive areas

Power supply

Power supply	2 cells, type: mono D, either – batteries (as delivered) – rechargeable batteries
Operating time, typical	30 hrs with disposable batteries

Data transmission

Transmission frequency	2.4 GHz
Radio range	maximum 800 m
Communications	Radio

Location

Receiving frequency	<ul style="list-style-type: none">• 75 active frequencies between 64 Hz and 200 kHz• passive frequencies:<ul style="list-style-type: none">– 50/60 Hz– 100/120 Hz– 150/180 Hz
Location depth	maximum 12 m error: <ul style="list-style-type: none">– active location: ±5 % up to 3 m– passive location: ±10 % up to 3 m– sondes: ±5 % up to 3 m

9.1.2 UT 9005 TX / UT 9012 TX generator

Device data

Dimensions (W × D × H):	295 × 180 × 260 mm
Weight	3.75 kg incl. batteries

Certificates

Certificate	FCC, IC, CE
Marking	Contains FCC ID: QOQWT41 IC: 5123-BGTWT41

Features

Display	Graphic liquid crystal display with LED back-light
Interface	USB
Controls	Membrane keypad with 4 keys

Operating conditions

Operating temperature	-20 °C – +50 °C
Storage temperature	-32 °C – +70 °C with batteries, rechargeable batteries -20 °C – +45 °C with lithium-ion rechargeable battery
Humidity	10 % – 90 % r.h., non-condensing
Atmospheric pressure	950 – 1,100 hPa
Protection rating	IP65
Non-permitted operating environments	in potentially explosive areas

Power supply

Power supply	either: – batteries or rechargeable batteries, 10 cells, type: mono D (as delivered) – lithium-ion rechargeable battery (integrated into special battery compartment cover)
Operating time, typical	100 hrs with disposable batteries 80 hrs with lithium-ion rechargeable battery

Data transmission





























Transmission frequency	2.4 GHz
Radio range	maximum 800 m
Communications	radio

Location

Transmitting frequency	75 active frequencies between 64 Hz and 200 kHz
Transmitting power	<ul style="list-style-type: none"> ● UT 9012 TX: 12 W, 5 power levels ● UT 9005 TX: 5 W, 5 power levels

9.2 Pre-set frequencies (factory settings)

9.2.1 UT 9000 R receiver

Frequency	suitable for
50 Hz	
60 Hz	
100 Hz	
120 Hz	
150 Hz	
180 Hz	
256 Hz	
263 Hz	
512 Hz	 
640 Hz	 
815 Hz	
1.02 kHz	
1.17 kHz	
8.19 kHz	 
9.5 kHz	
9.82 kHz	
32.8 kHz	 
44.6 kHz	
80.4 kHz	
83.1 kHz	 
116 kHz	
131 kHz	
200 kHz	







































Explanation of symbols:

 current





 line

 sonde

9.2.2 UT 9005 TX / UT 9012 TX generator

Frequency	suitable for	
256 Hz		
263 Hz		
512 Hz		
640 Hz		
815 Hz		
1.02 kHz		
1.17 kHz		
8.19 kHz	 	
9.5 kHz		
9.82 kHz	 	
32.8 kHz	 	
44.6 kHz	 	
80.4 kHz	 	
83.1 kHz	 	
131 kHz	 	
200 kHz		

Explanation of symbols:

-  galvanic energising
-  inductive energising
-  cable clamp for low frequencies
-  cable clamp 5" (default)

9.3 Accessories and consumables

Accessories

Part	Order number
UT 9000 5" cable clamp	UT90-Z1000
UT 9000 simple set of cables	UT90-Z0100
UT 9000 double set of cables	UT90-Z0300
lithium-ion rechargeable battery	UT90-Z0500
UT 9000 Euro AC/DC adapter	LD90-10000
step-voltage probe	UT90-Z1100

Consumables

Part	Order number
Battery, mono, LR20	1353-0003

Other accessories and consumables are available for the product. Please contact our SEWERIN sales department for further information.

9.4 EC Declaration of Conformity

Hermann Sewerin GmbH hereby declares that the **UT 9000** fulfils the requirements of the following directives:

- 1999/5/EC
- 2004/108/EC
- 2006/95/EC

The complete declarations of conformity can be found online.

9.5 Advice on disposal

The European Waste Catalogue (EWC) governs the disposal of appliances and accessories.

Description of waste	Allocated EWC waste code
Device	16 02 13
Disposable battery, rechargeable battery	16 06 05 / 20 01 34

End-of-life equipment

Used equipment can be returned to Hermann Sewerin GmbH. We will arrange for the equipment to be disposed of appropriately by certified specialist contractors free of charge.

10 Index

A

active location 49, 62
ambient noise 49
 menu item 19
audio mode 17
audio style 18
autodepth 18

B

backlight 15, 28
Bluetooth 16

C

cable clamp 56
communications 16, 30
compass 11
configure
 generator 27
 receiver 13
 via the software 47
control panel 7, 23
coordinates 6
current (location type) 5

D

defaults 32
depth 44
 automatic 45
 display on the screen 10
 manual 45
 measurement type 44
 menu item 18
 offset depth 45
 unit 44
devices
 link 39
 pairing 39
 un-link 40
 update 47
diamond 11
directional arrows 11
direction enabled 29
direction recognition 58
 menu item 29

display 9
 graphical elements 11
 symbols 12, 24
distinguishing battery compartments 34
dual output 29

E

energising 51
 galvanic 51
 inductive 55
 with cable clamp 56

F

fault mode 33
field strength 9
frequency
 available 41
 display on the screen 26
 enable 42
 enabled 41
 menu item 14, 28
 pre-set 41
 select 42
 suitability for location 49

G

gain
 display on the screen 10
 manual adjustment 44
 menu item 18
 on the receiver 43
 semi-automatic adjustment 44
galvanic energising 51
generator 22
 battery compartment 34
 changing the batteries 35
 configure 27
 controlling via the receiver 20
 control panel 23
 display 24
 menu 27
 power supply 34
 tone 22

H

high power 29, 60

I

inductive energising 55

L

language 15, 31

LED 38

line

 energising 51

 location 49, 57

 location type 5

link information 17, 31

lithium-ion rechargeable battery

 charging 37

 safety information 36

 storage 36

 storage conditions 36

location

 active 49

 adjacent lines 68

 error 68

 line 49, 57

 passive 65

 sonde 62

 suitable frequency 49

location mode 5

location type 5

M

maximum

 narrow 6

 wide 6

menu

 exiting 14, 27

 open 13, 27

 opening a menu item 14, 27

meter 30

minimum 6

O

offset depth

 determining 45

 menu item 18

operating mode 22

options 17, 31

output 28

output power 12 W 60

P

parallel connection 52

 pre-allocation of the cable 53

parameters 26

passive location 65

pipe location *see* locating a line

pitch 17

point 11

power level 23

power supply

 external (generator) 35

 generator 34

 internal (generator) 34

 receiver 20

pre-allocation of the cable

 change 53

 reset 53

R

radio connection 16, 30

radio (location type) 5

radio on/off 16, 30

receiver 4

 changing the batteries 21

 configure 13

 control panel 7

 display 9

 gain 43

 menu 13

 power supply 20

 signal reception 4

 volume 4

rechargeable battery *see* lithium-ion
 rechargeable battery
reset 32
RX
 link 31
 un-link 31

S

set of cables
 double 51
 simple 51
 to be noted when changing 54
settings
 change 14, 27
 menu item 28
shutdown timer 15
signal behaviour 6
 coordinates 6
 maximum 6
 minimum 6
software 47
 configuring devices 47
 updating devices 47
sonde
 location 62
 location type 5
step-voltage probe 33
symbols 12, 24
system info 19, 33

T

timer 28, 29
tips 11
turn arrows 11
TX
 -control 19
 link 17
 un-link 17

U

units 15
use, intended 3
UT 9000 R *see* receiver
UT 9005 TX *see* generator
UT 9012 TX *see* generator

Y

Y-cable 51
pre-allocation 53

